

10th October 2023
TUC312

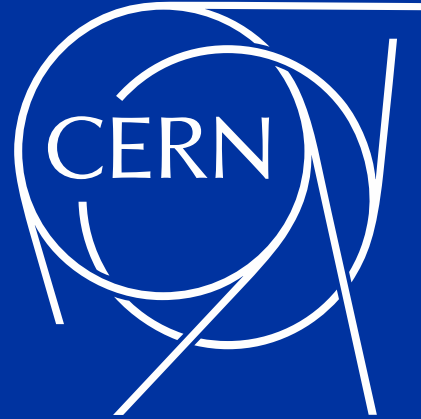

Shaping High Brightness and Fixed Target Beams with the CERN PSB Charge Exchange Injection

C. Bracco, S. Albright, F. Asvesta, G.P. Di Giovanni and F. Roncarolo

Acknowledgments:

ABT colleagues: B. Balan, J. Borburgh, G. Grawer, L.O. Jorat, R. Noulibos, N. Magnin E. Renner, P. Van Trappen and W. Weterings

ABP colleagues: H. Bartosik, T. Prebibaj and E.H. Maclean

BI colleagues: S. Burger, A. Navarro Fernandez

B. Mikulec and the full PSB OP team with a special mention to A. Akroh

Outline

- **The PS Booster (PSB) and its history**
- **Why 160MeV H⁻ charge exchange injection?**
- **Details about concept, hardware and diagnostics**
- **Operational experience from commissioning until today**

The PS Booster

Four superposed synchrotron rings (25 m radius) providing beam to the PS and ISOLDE

Multi-turn injection to accumulate charges

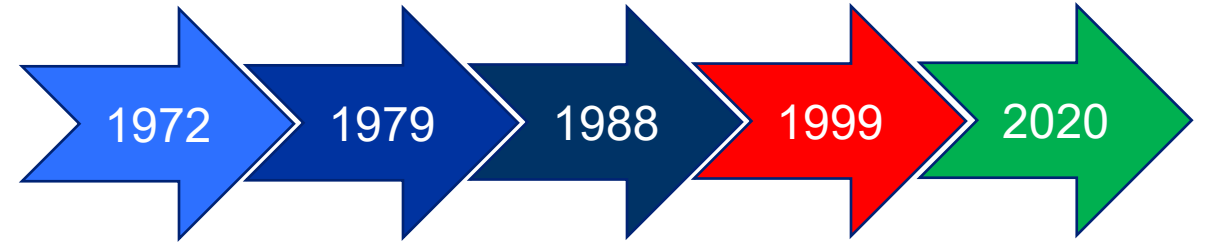
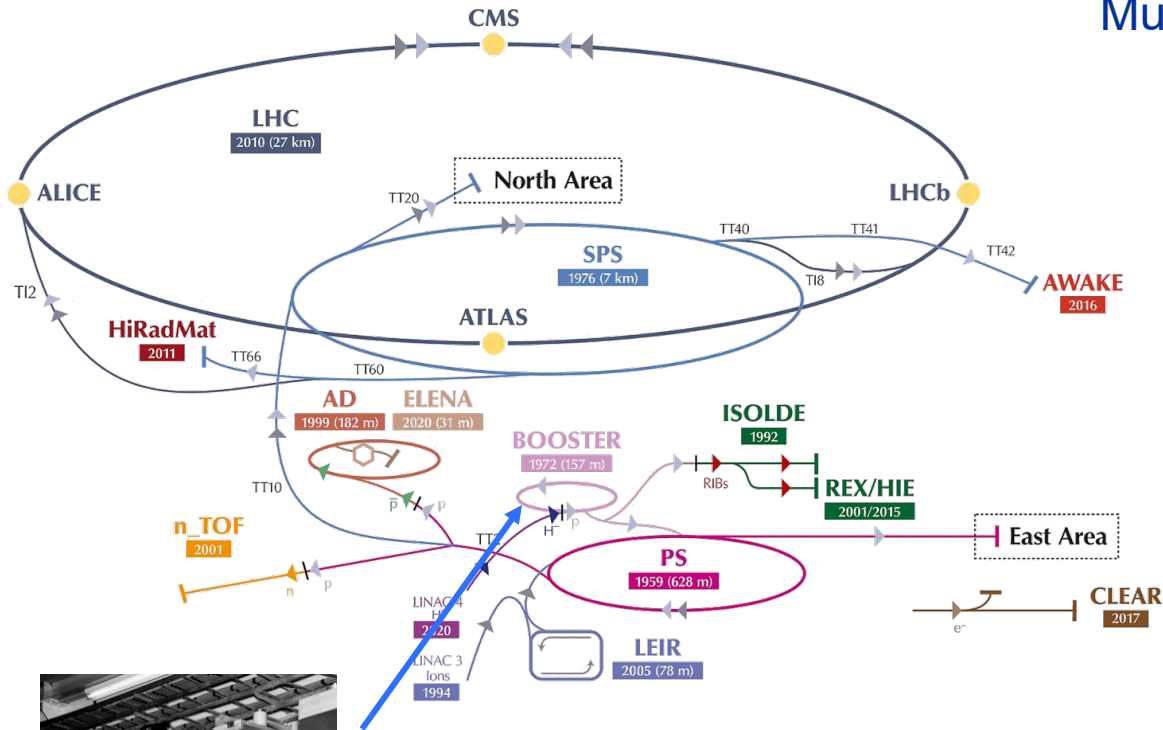

50 MeV p+ beam from Linac1 accelerated up to 800 MeV

50 MeV p+ beam from Linac2

Beam accelerated up to 1 GeV

Beam accelerated up to 1.4 GeV

160 MeV H⁻ beam from Linac4 accelerated up to 2 GeV

Higher energy and H⁻ instead of protons to overcome brightness limitations

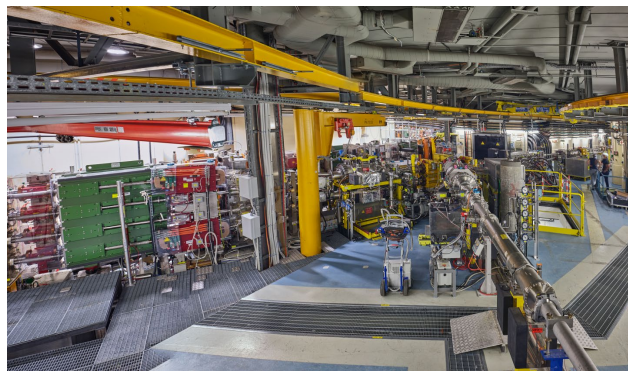
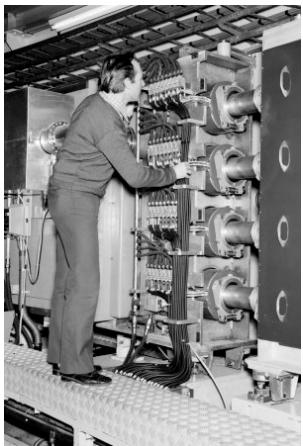

HL-LHC Challenge

The High Luminosity LHC (HL-LHC) upgrade

Aims at **3000 (4000) fb⁻¹** total integrated luminosity over HL-LHC run (2029 – 2041)

Based on operation at levelled luminosity of **5 (7.5) x10³⁴ cm⁻²s⁻¹** by lowering β^*

	N_b (x 10 ¹¹ p/b)	$\epsilon_{x,y}$ (mm)	Bunch/batch spacing	Bunches
HL-LHC	2.3	2.1	25 ns / 200 ns	4x72 per injection
Pre LS2	1.3	2.7	25 ns / 200 ns	4x72 per injection

→ ~double intensity and double brightness

The PSB Challenges

Pre-LS2

Beam Type	Total intensity per ring [10^{10}]	$\epsilon_{x,norm,rms}$ [mm mrad]	$\epsilon_{y,norm,rms}$ [mm mrad]	$\epsilon_{long.}$ [eVs]
LHC PROBE	0.5-2	0.8	0.8	0.2
LHC INDIV	2 (12)	<2	<1.5	0.3
LHC INDIV_VDM	10	~2.5	~2.5	0.3
LHC 25ns DB_A/B	165	~2	~2	1.3
LHC 50ns DB_A/B	~80	~1.5	~1	1.3
BCMS 25ns DB_A/B	85	<1.1	<1.2	0.9
LHC 8b4e_BCS	45-60	~0.6	~0.6	~0.82
LHC 8b4e DB_A/B	~165	~2	~2	1.3
AD	400±50	9	5	<1.3
EAST1	<60	<1.5	<1.5	<1.3
EAST2	50-67	<1.5	<1.5	<1.3
SFTPRO_MTE	<600	~6-8	~5-6	1.3
TOF	850	11	9	1.7
NORMGPS/HRS	900	10	6	<1.8
STAGISO 1.4GeV	~200/350	<5	<4	<1.6

LIU Targets

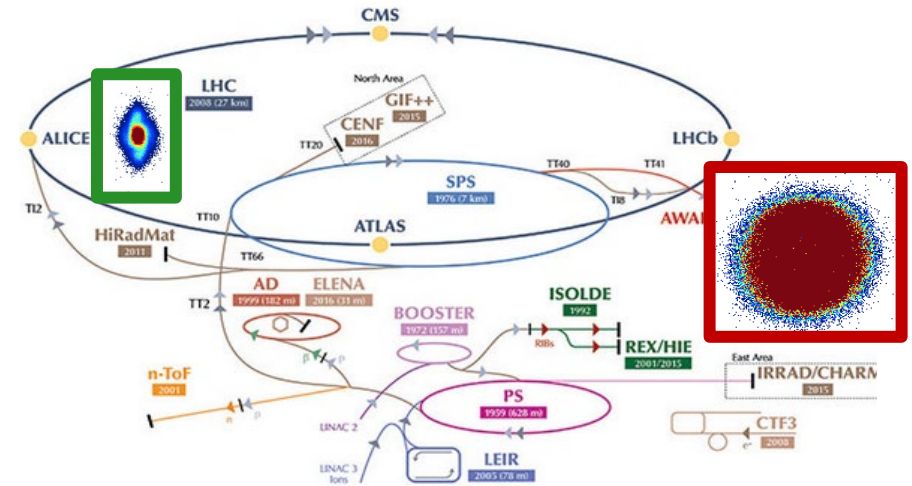

HL-LHC: High Brightness

$\epsilon_{x,n}/\epsilon_{y,n}$: <1.7 mm mrad

Intensity: 3.4 E12 ppr

ISOLDE: High Intensity

$\epsilon_{x,n}/\epsilon_{y,n}$: <15/9 mm mrad

Intensity: ≥ 1.6 E13 ppr

Emittance constraints only defined by aperture limitations and loss reduction

The new PSB H⁻ Injection System

E. Renner

Horizontal closed orbit bump produced by injection chicane (BSW) + kicker magnets for painting (KSW)

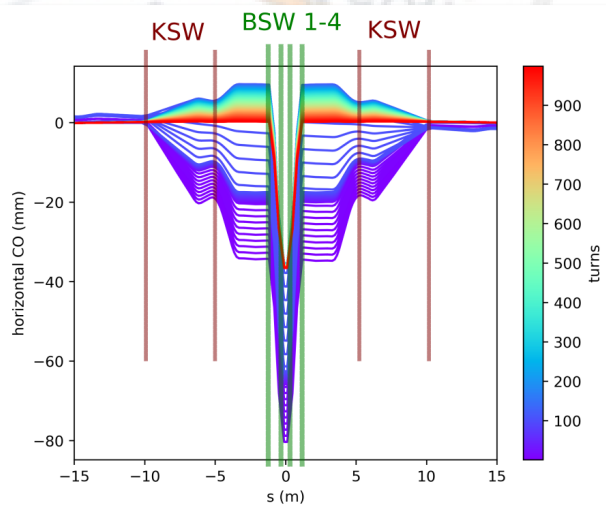
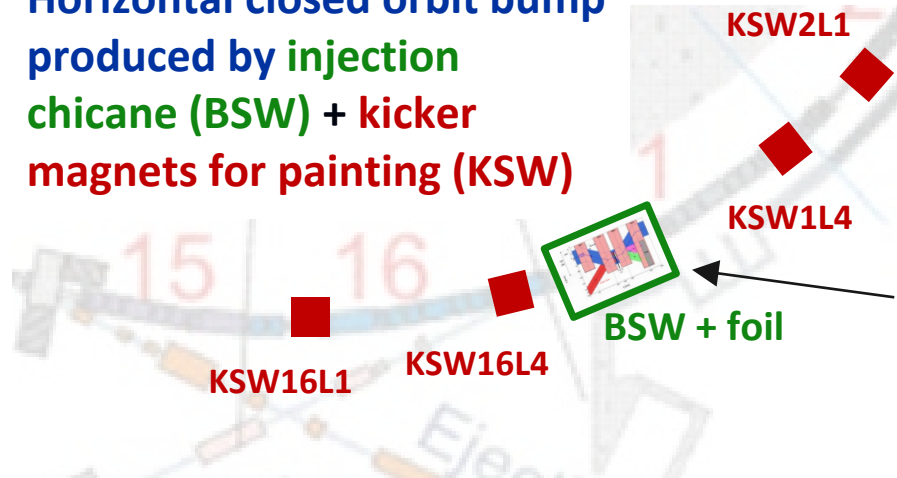

Closed orbit during KSW decay, ISOLDE beam

Injection Chicane + Stripping Foil

- 4 horizontal chicane magnets (BSW)
- 46 mm orbit bump during injection, decays within 5000 turns (5 ms)
- Stripping foil

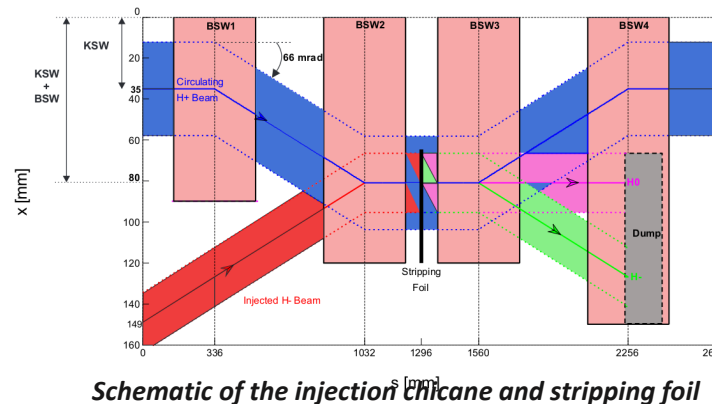

Schematic of the injection chicane and stripping foil

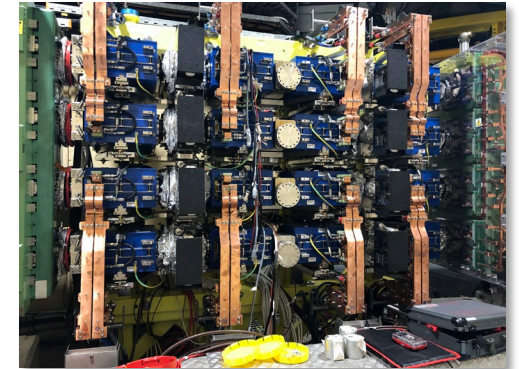

Newly installed H- injection (top) and pre-LS2 multi-turn injection (bottom)



The Injection Chicane

R-Bends, 66 mrad kick each

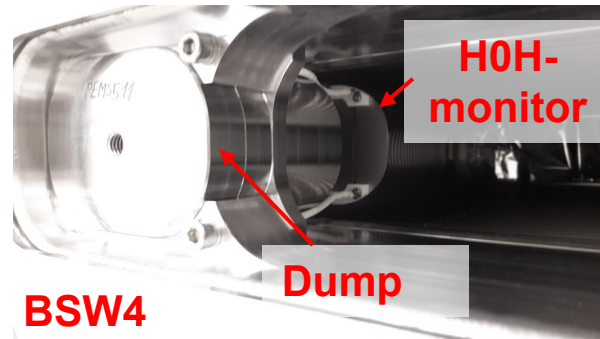
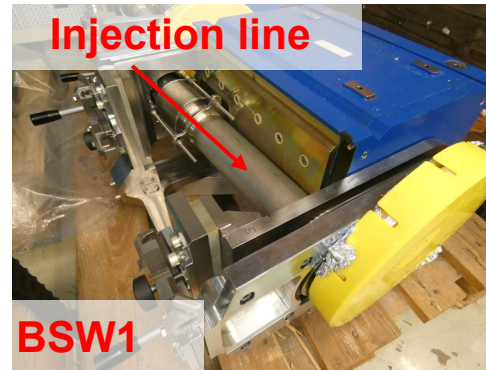
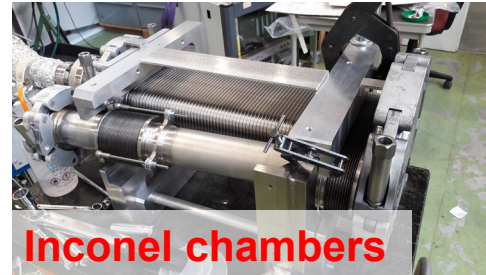
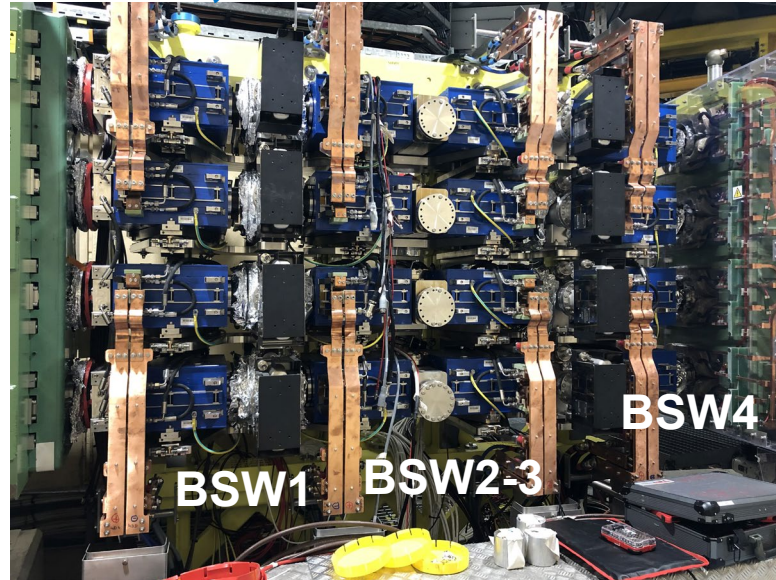

Table 1: Main BSW Magnet Parameters

Parameters	Unit	BSW1	BSW2-4
$\int B_y dl$ at magnet centre	mTm	126	126
Electric peak current	kA	6.7	3.4
RMS current	A	463	231
Resistance	m Ω	3.5	7
Inductance	μ H	13	77
Number of turns		4	8
End Plate thickness	mm	13.6	12
Aperture H \times V	mm	162 \times 85	242 \times 85
Good field region 1%	mm	140 \times 85	220 \times 85

BSWs:

- Rectangular pulsed magnets, independently powered, which apply a kick of 66 mrad
- Quadrupolar field perturbations are generated in the vertical plane due to the strong edge focusing.
- Eddy currents induced in the metallic chambers during the decay of the field create sextupolar field components.
- Both effects translate in a vertical β -beating which can be corrected with k-modulation

T. Prebibaj

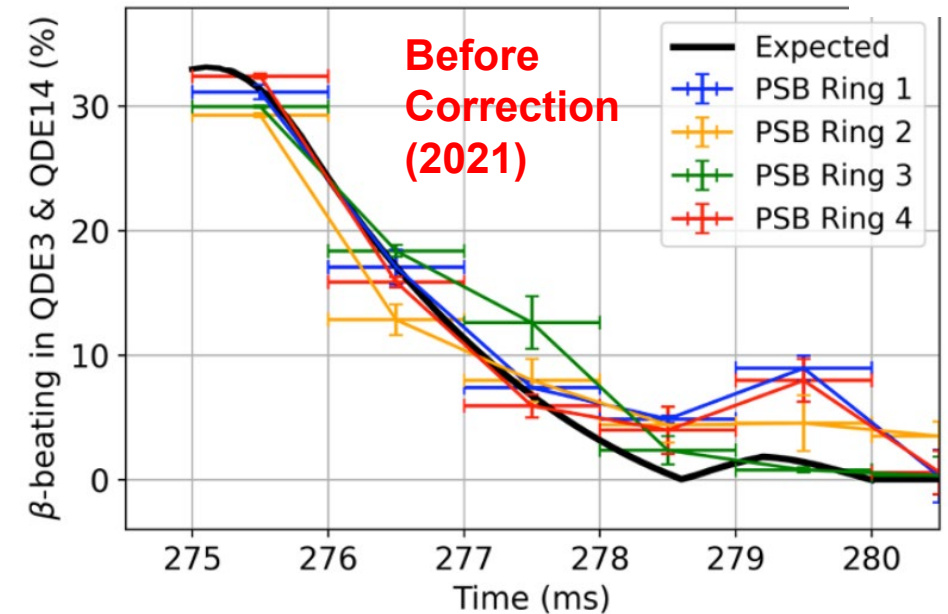

The Injection Chicane

R-Bends, 66 mrad kick each

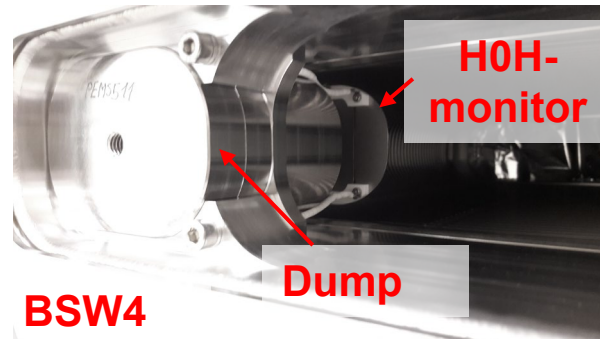
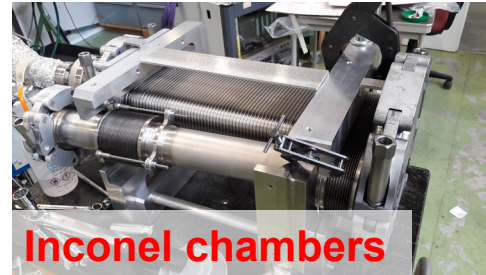
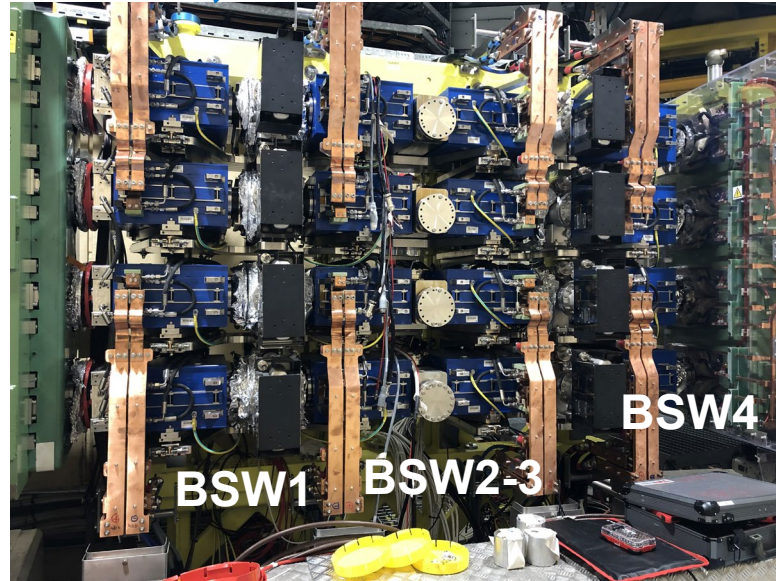

Table 1: Main BSW Magnet Parameters

Parameters	Unit	BSW1	BSW2-4
$\int B_y dl$ at magnet centre	mTm	126	126
Electric peak current	kA	6.7	3.4
RMS current	A	463	231
Resistance	m Ω	3.5	7
Inductance	μ H	13	77
Number of turns		4	8
End Plate thickness	mm	13.6	12
Aperture H×V	mm	162x85	242x85
Good field region 1%	mm	140x85	220x85

BSWs:

- Rectangular pulsed magnets, independently powered, which apply a kick of 66 mrad
- Quadrupolar field perturbations are generated in the vertical plane due to the strong edge focusing.
- Eddy currents induced in the metallic chambers during the decay of the field create sextupolar field components.
- Both effects translate in a vertical β -beating which can be corrected with k-modulation

T. Prebibaj

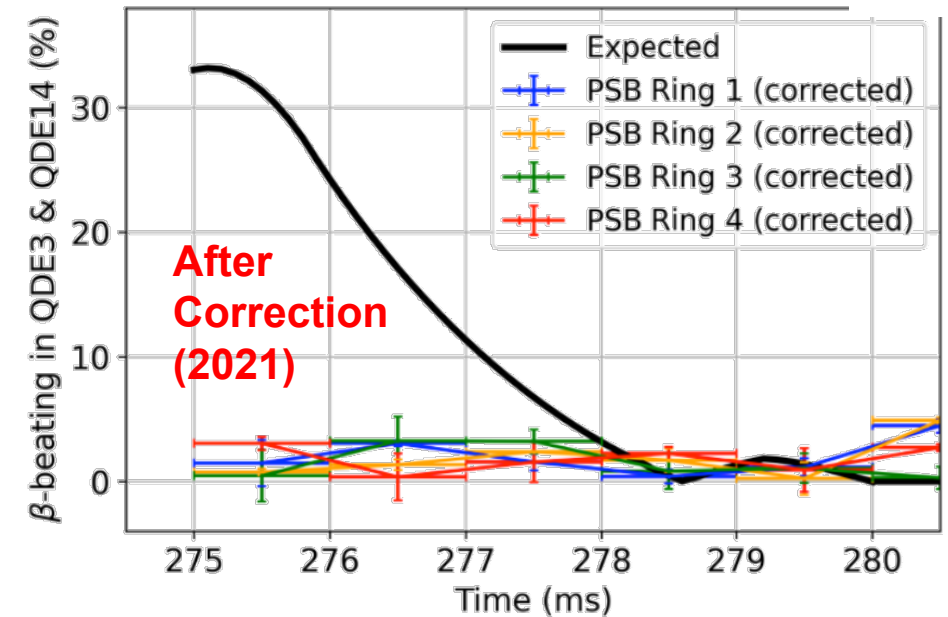

Better control of WP along the cycle

The Painting Bumpers

- Need to provide beams to a **large variety of users**
- Painting process + accurate choice and control of **WP** during cycle allow to fulfil requirements and mitigate space charge
- **Painting bump** produced by **4 KSW + 6 interpose Quads**
- **Multiple-linear waveform** generator was developed to ensure the necessary high flexibility.
- Each magnet **independently powered** to adapt to differences between users, rings and for fine tuning

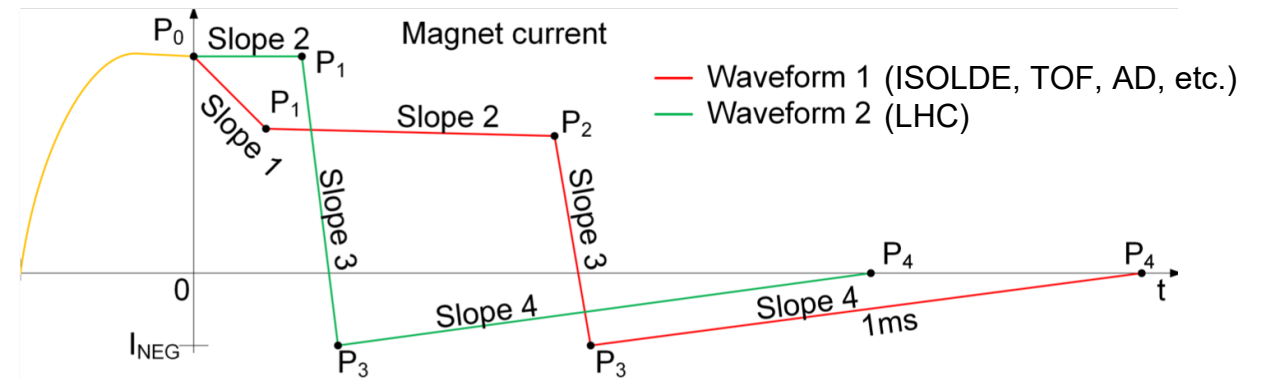
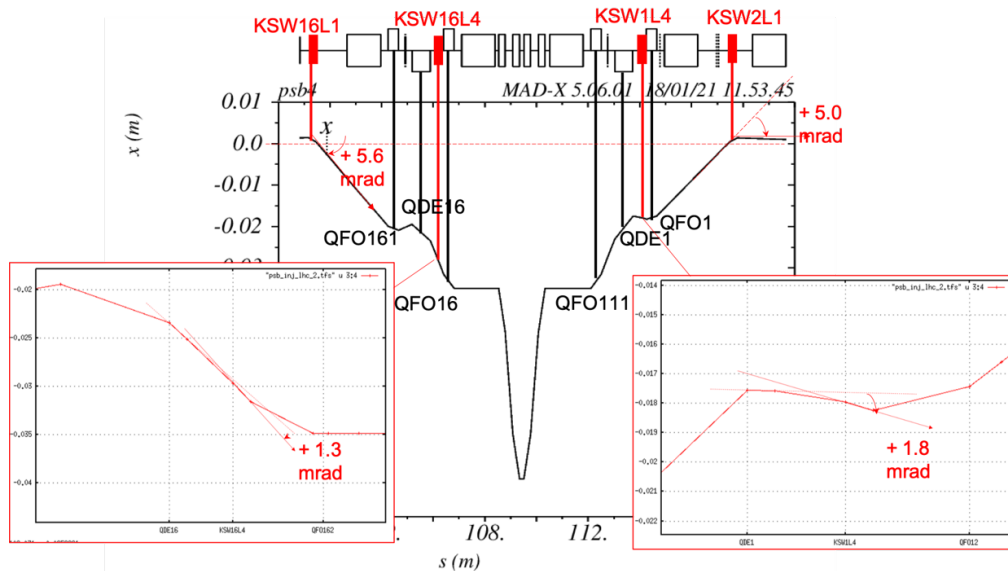

The Painting Bumpers

- Need to provide beams to a **large variety of users**
- Painting process + accurate choice and control of **WP** during cycle allow to fulfil requirements and mitigate space charge
- **Painting bump** produced by **4 KSW + 6 interpose Quads**
- **Multiple-linear waveform** generator was developed to ensure the necessary high flexibility.
- Each magnet **independently powered** to adapt to differences between users, rings and for fine tuning

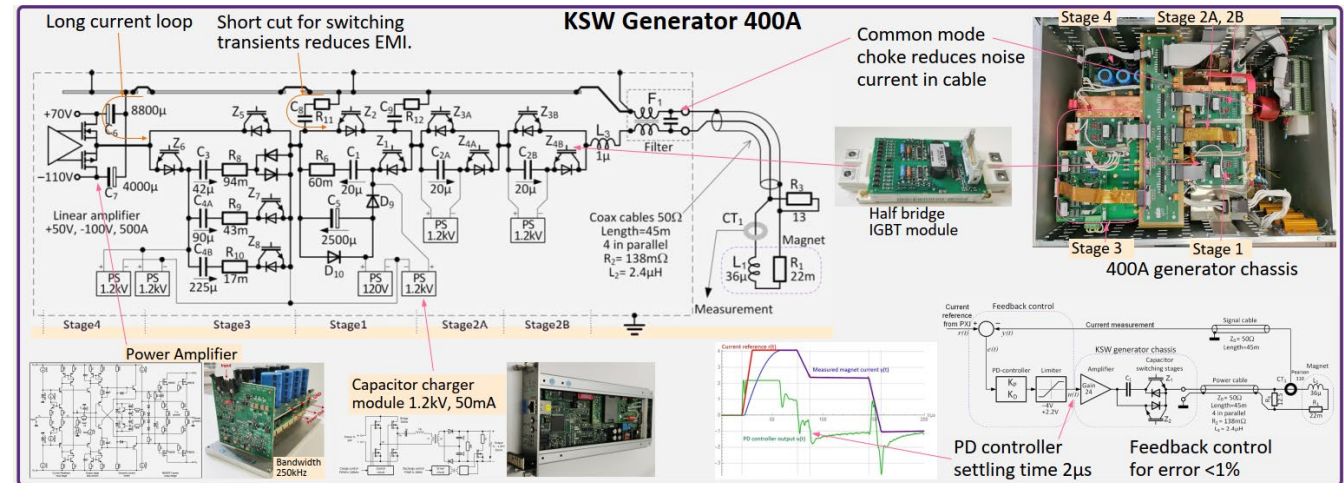
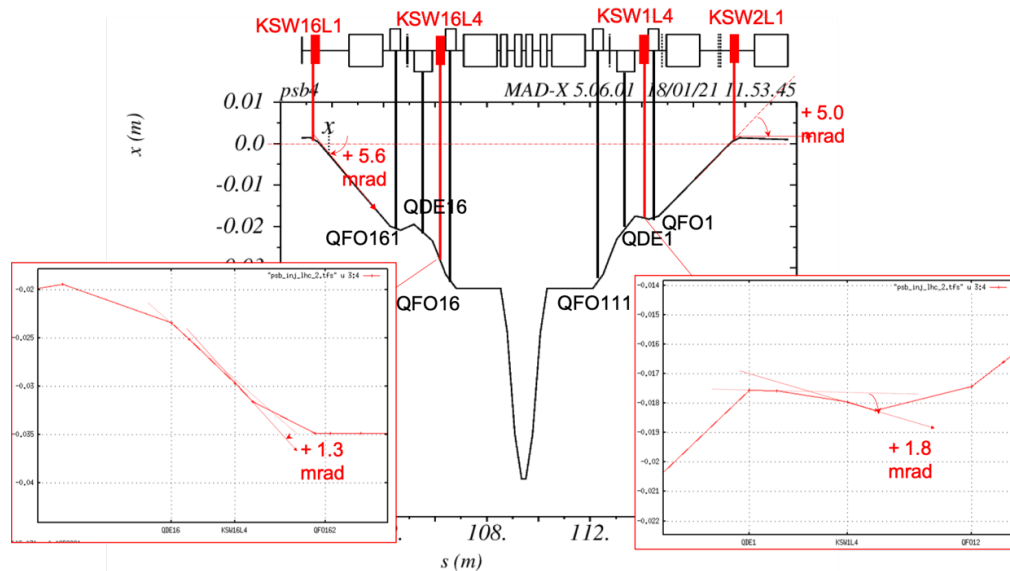

The Painting Control

A control interface was deployed to allow users setting up the waveforms for all the users

ISOLDE

Linac4 BCTs

BCTs	Ring4	Ring3	Ring2	Ring1	Sum
BI.BCT10	-823.5	-823.34	-829.66	-827.96	
BI.BCT20	-839.51	101.94%	-822.18	99.80%	-826.9
Injection	822.14	97.95%	816.06	99.26%	811.62
Capture	821.31	99.9%	812.61	99.58%	800.02
Acceleration	815.92	99.24%	808.05	99.44%	805.28
BT.BCT10					3,217.29
BTP.BCT10					1.09
BTM.BCT10					8.28
BTY.BCT112					3,138.02
BTY.BCT183					3,098.06
BTY.BCT213					1.85
BTY.BCT325					3,238.79

PSB Inj. Ring & Transfer BCTs

BCTs	Ring4	Ring3	Ring2	Ring1	Sum
BI.BCT10					3,217.29
BTP.BCT10					1.09
BTM.BCT10					8.28
BTY.BCT112					3,138.02
BTY.BCT183					3,098.06
BTY.BCT213					1.85
BTY.BCT325					3,238.79

Machine Watchdogs status

- WD DUMP: 3/3
- WD L4L: 3/3
- WD L4T: 3/3
- WD LBE: 3/3
- WD BI: 3/3
- WD BR4: 4/4
- WD BR3: 3/3
- WD BR2: 3/3
- WD BR1: 3/3
- Reset BR WDs

Waveform Graphs (Amplitude [mm] vs Time [us]):

- BI4.KSW: t0,A0, t1,A1, t2,A2
- BI3.KSW: t0,A0, t1,A1, t2,A2
- BI2.KSW: t0,A0, t1,A1, t2,A2
- BI1.KSW: t0,A0, t1,A1, t2,A2

Current measured by BCTs in the injection line

Current measured by BCTs in the PSB at injection (after 1 ms), after capture and at the end of the acceleration process

Current measured in TL to PS, ISOLDE and dump

Number of injection turns (set) and Linac4 chopping factor (set)

Interlock status

A. Akroh

The Stripping Foil System and Diagnostics

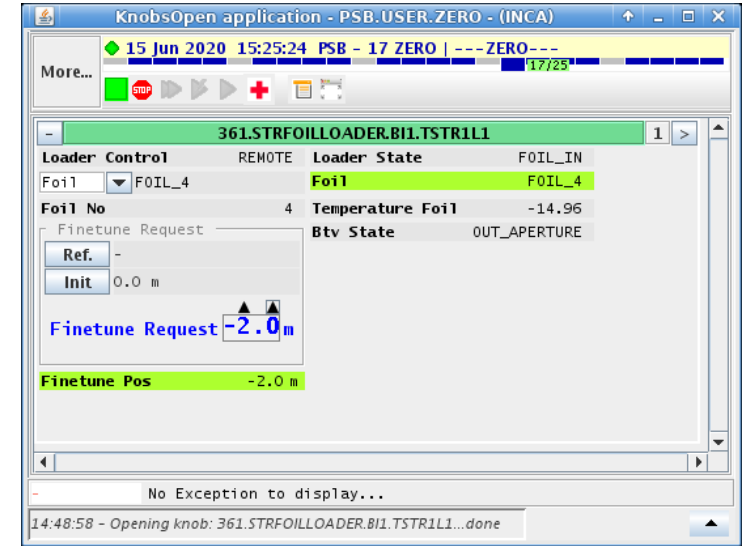
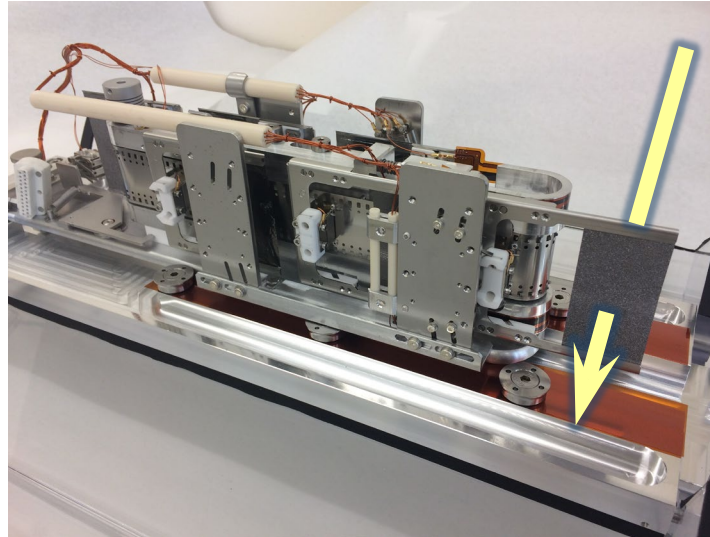
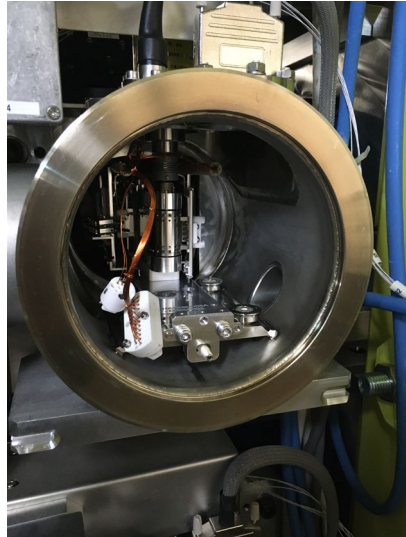
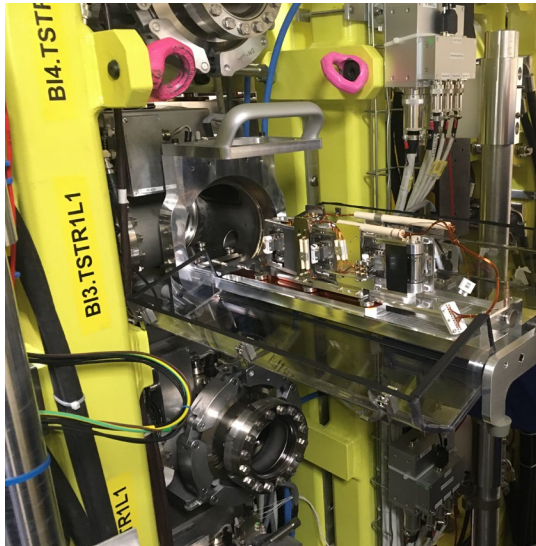

Each ring is equipped with a loader hosting 6 stripping foils.

This gives the possibility to replace broken foils without intervening locally in the machine.

The mechanism allows a ± 2 mm fine adjustment in the transverse position

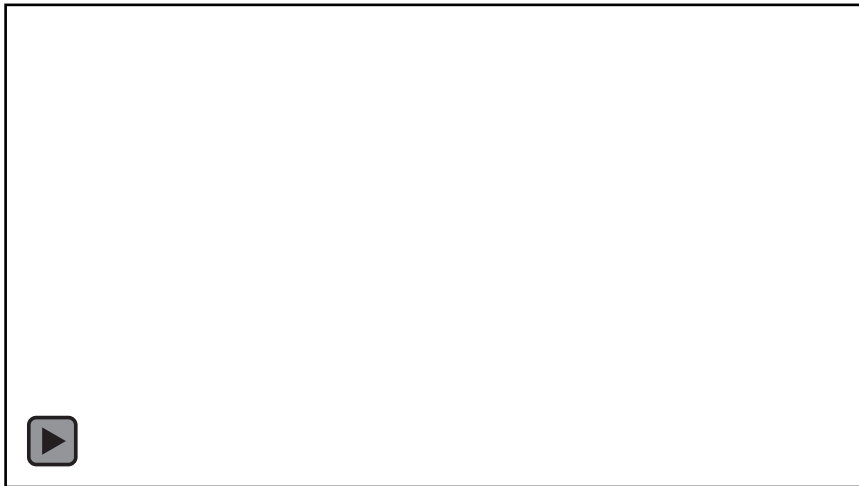

The PSB Stripping Foil System and Diagnostics

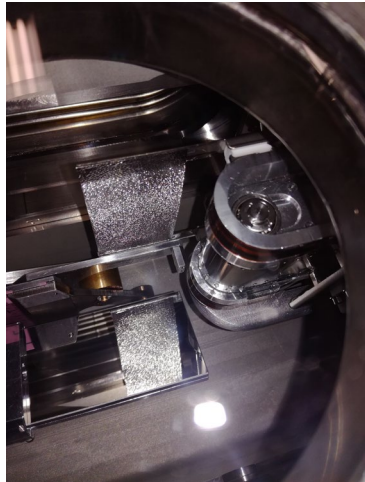

- A BTV screen installed right in front of the stripping foil to:
 - Fine tune foil position
 - Steer the beam to target position (2 H/V correctors in TL)
 - Measure beam profile
 - Online check of foil status

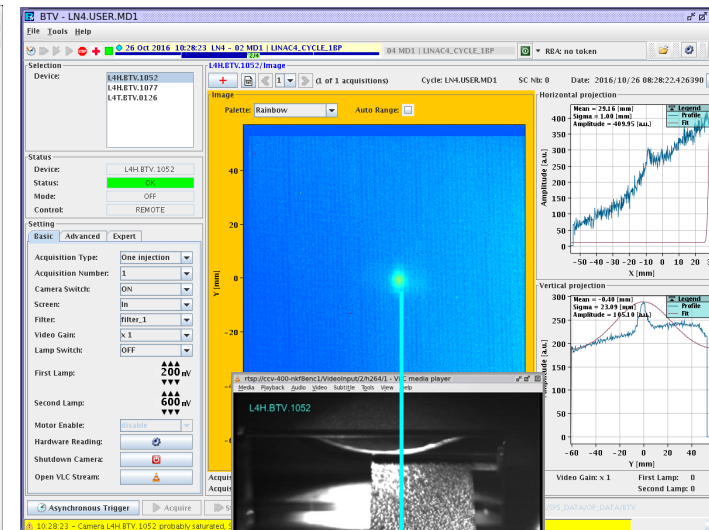
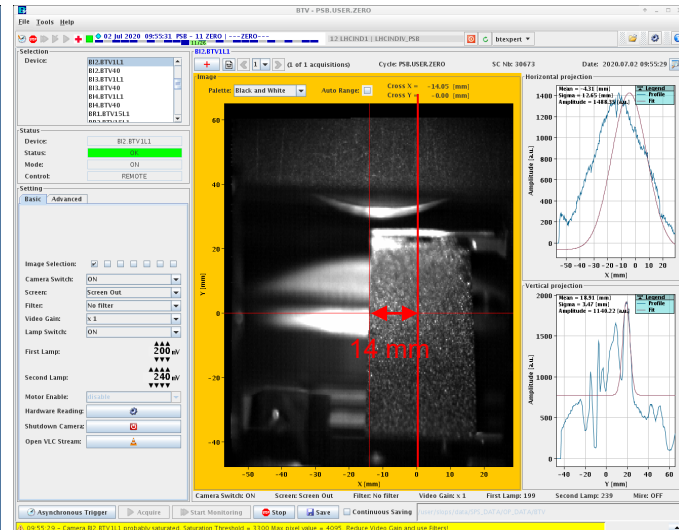
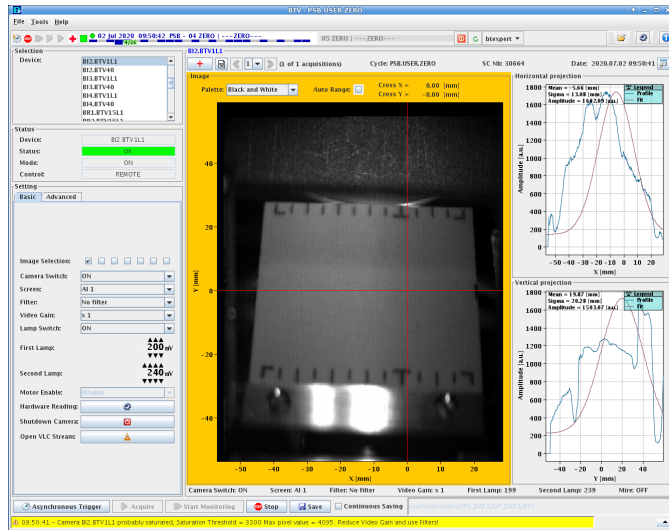

The PSB Stripping Foil System and Diagnostics

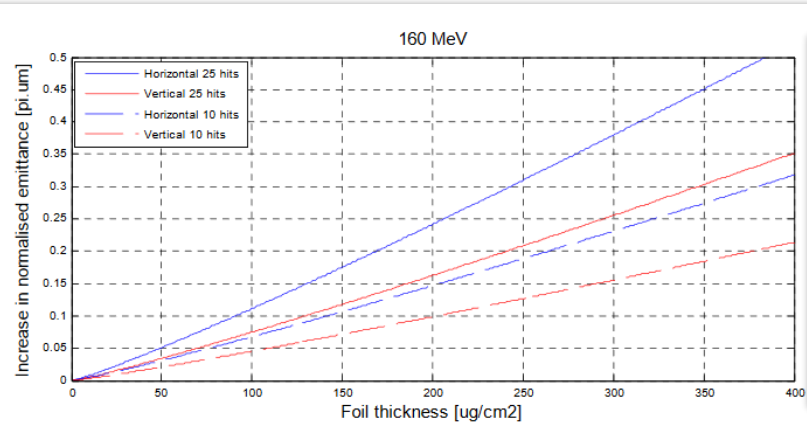

SLHC Project Note 0005
2009-11-30
brennan.goddard@cern.ch

Stripping foils for the PSB H⁻ injection system
M.Aiba (PSI), C.Carli, B.Goddard, W.Weterings
Keywords: Linac4, PSB charge exchange injection

Summary
Beam physics considerations for the stripping foil of the PSB H⁻ injection system are described, including the arguments for the foil type, thickness, geometry and positioning. The foil performance considerations are described, including expected stripping efficiency, emittance growth, energy straggling, temperature and lifetime. The required movement ranges and tolerances are detailed, together with the assumptions used.

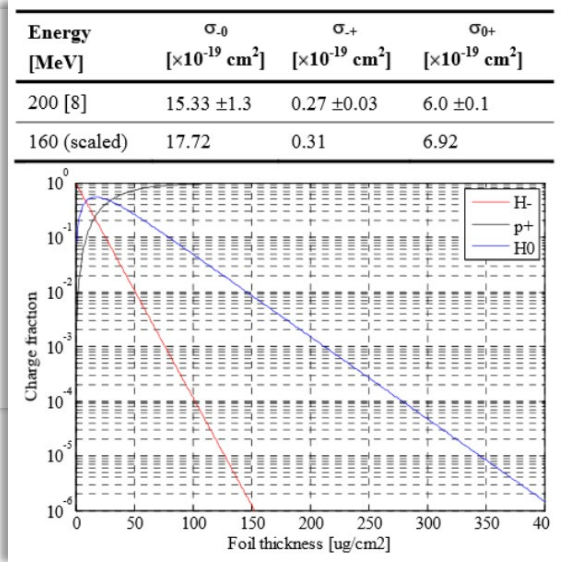
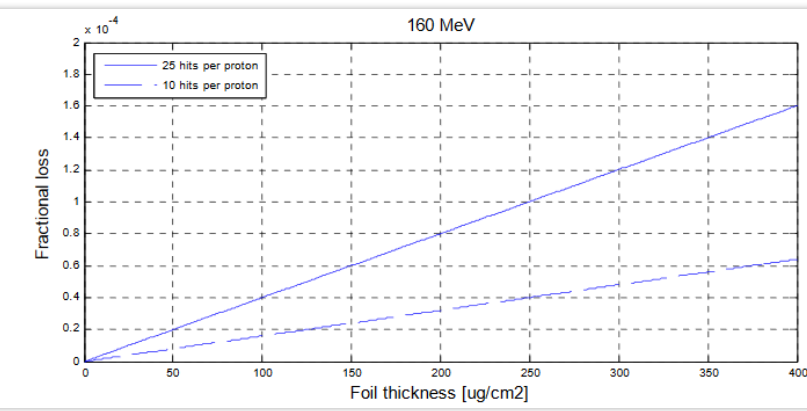

Foil thickness defined to:

- Maximise stripping efficiency ($\geq 98\%$)
- Minimise emittance blow-up
- Minimise Losses
- Minimise power deposition

$\sim 200 \mu\text{g cm}^{-2}$ C-based foils ($\sim 1 \mu\text{m}$) chosen for PSB

Foils on loaders:

- XCF-200 (Loader 1&4): arc evaporated amorphous carbon, collodion coated
- MLG-250 (Loader 2&5): multilayer graphene
- GSI-200 (Loader 3&6): arc evaporated amorphous carbon

M. Aiba



The PSB Stripping Foil System and Diagnostics

H0/H- Current Monitor (1 mm Ti plates) installed in front of the 70 mm long Ti dump allows (after calibration) to:

- Measure stripping efficiency

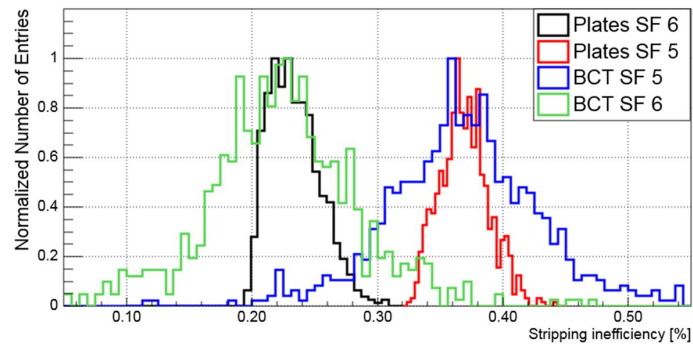

Current measurements in HST (no foil)

- Measure beam position and adjust angular steering of injected beam to be perpendicular to the foil

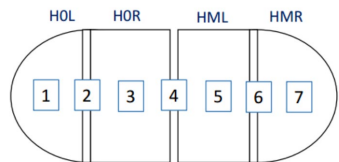

Position scan in HST (no foil)

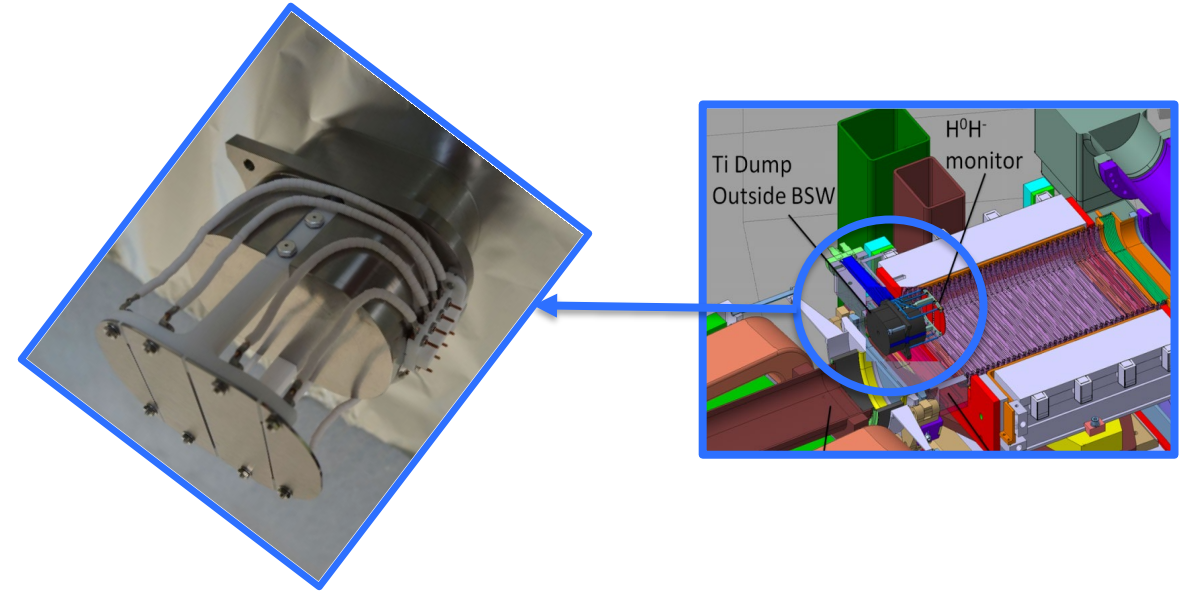
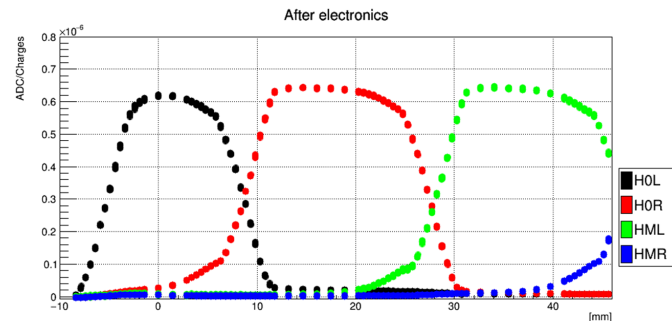

Interlocks in place to detect:

- Loss in stripping efficiency (10% injected beam)
- Foil breakage (100% injected beam)

Commissioning 2020/2021

- Steering of beam through TLs up to 4 injection points at reference position on BTV
- First beam injected into the PSB on December 9th 2020

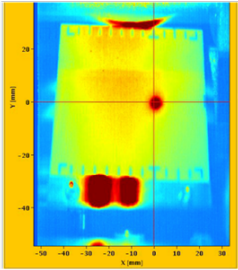
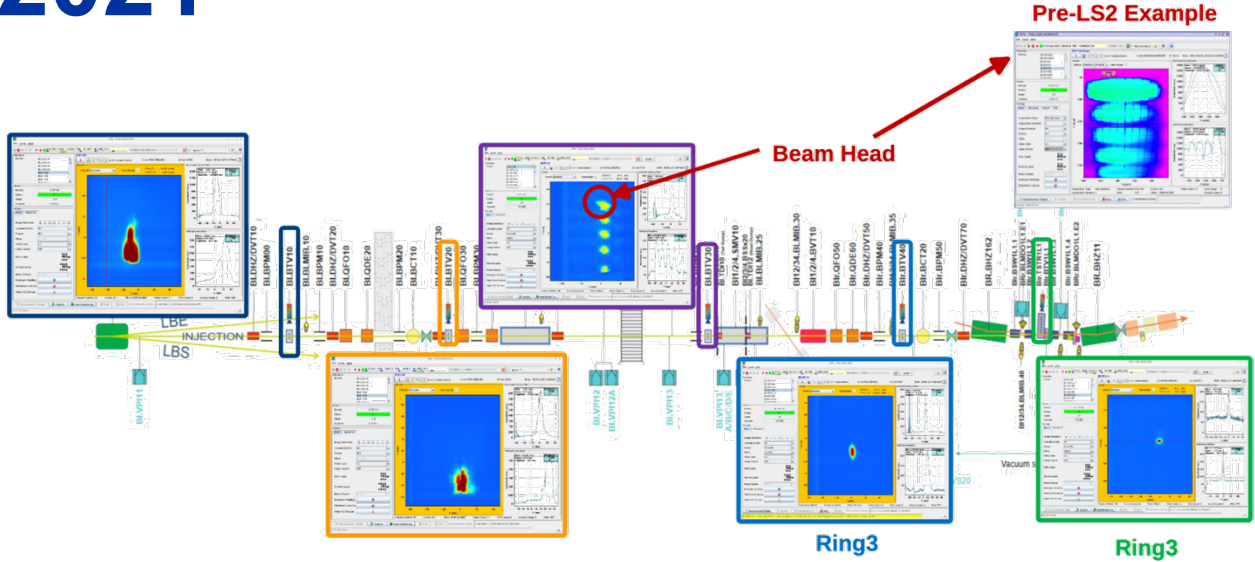

Injected beam at reference position at screen in front of stripping foil (BTV1L1)

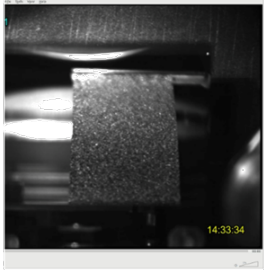

Inserted stripping foil for injection

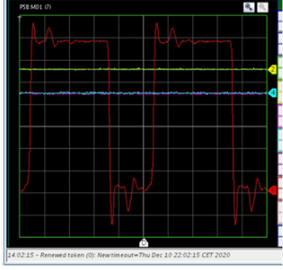

Validate stripping efficiency: zero signal at H0/H- monitor when foil is inserted

Beam seen at BTV in period 15, after nearly 1 turn

Two turns seen by RF team with phase pick up

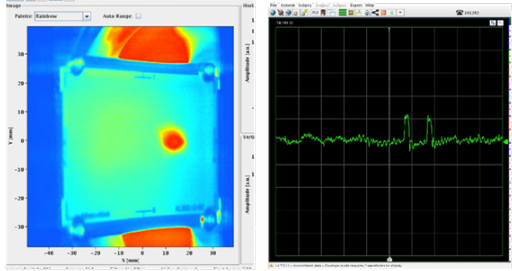

Beam captured and circulating with minor losses (low intensity 1-3 turns) after a few days

Commissioning 2020/2021

- Angular steering centering beam at H0 monitor with **no foil** and **BSW OFF** → Beam not centered at H-monitor with **BSW ON** + large horizontal orbit leakage before BSW decay when injecting beam in the ring

No foil + BSW OFF

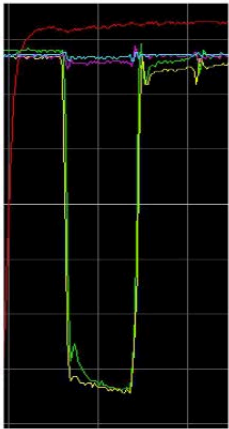
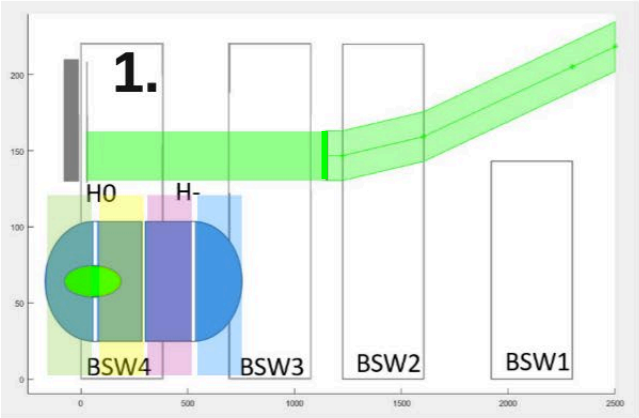

No foil + BSW ON

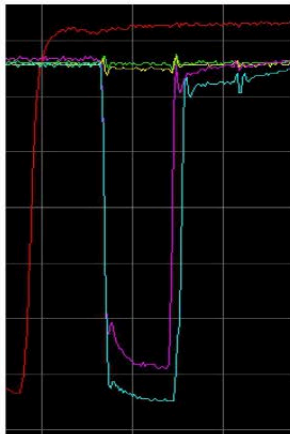
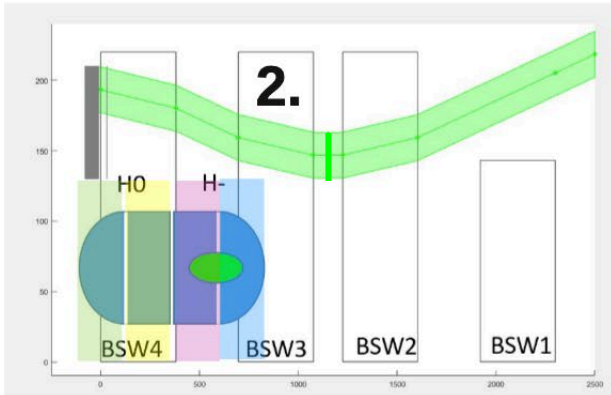

Foil + BSW ON

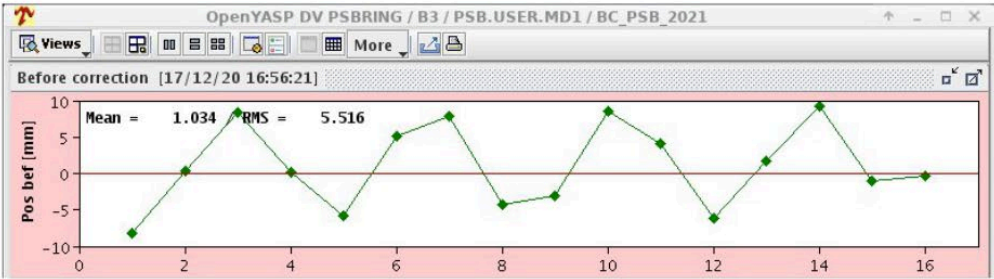

closed orbit difference to closed orbit after decay of BSW bump, before correction of BSW 2-4

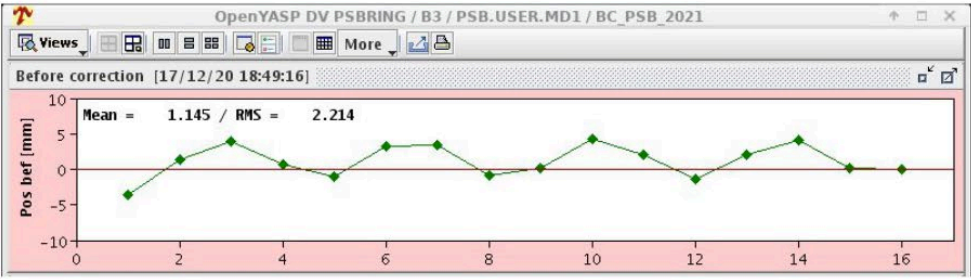

closed orbit difference to closed orbit after decay of BSW bump, after correction of BSW 2-4

Commissioning 2020/2021

- **Angular steering** centering beam at **H0** monitor with **no foil** and **BSW OFF** → **Beam not centered at H-** monitor with **BSW ON** + **large horizontal orbit leakage** before BSW decay when injecting beam in the ring
- **Nominal current** of **BSW2,3** and **4** (3400 A) had to **be reduced by 3%** and **BSW1** current (6700 A) **increased by 2.5%** for **Ring1,3** and **4** and **3%** for **Ring2** to **minimize the orbit leakage** → H- beam correctly centred at H0 and H- with BSW OFF and ON

No foil + BSW OFF

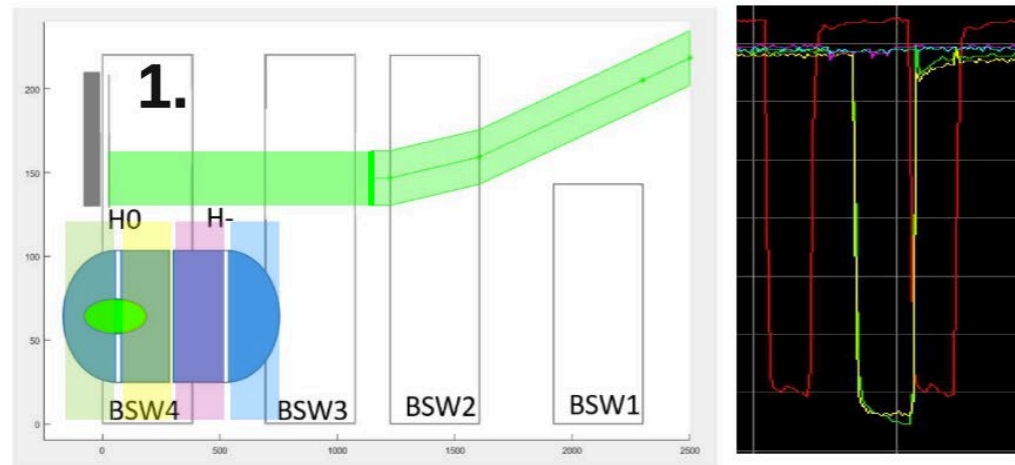

No foil + BSW ON



Commissioning 2020/2021

- **Angular steering** centering beam at **H0 monitor** with **no foil** and **BSW OFF** → **Beam not centered** at **H-monitor** with **BSW ON** + **large horizontal orbit leakage** before BSW decay when injecting beam in the ring
- **Nominal current** of **BSW2,3** and **4** (3400 A) had to **be reduced by 3%** and **BSW1** current (6700 A) **increased by 2.5%** for **Ring1,3** and **4** and **3%** for **Ring2** to **minimize the orbit leakage** → H- beam correctly centred at H0 and H- with BSW OFF and ON
- **Vertical steering** only adjusted by **minimising the injection oscillations**, through orthogonal steering, with respect to the closed orbit established with all the bumps off

Commissioning 2020/2021

- **Angular steering** centering beam at **H0 monitor** with **no foil** and **BSW OFF** → **Beam not centered** at **H-monitor** with **BSW ON** + **large horizontal orbit leakage** before BSW decay when injecting beam in the ring
- **Nominal current** of **BSW2,3** and **4** (3400 A) had to **be reduced by 3%** and **BSW1** current (6700 A) **increased by 2.5%** for **Ring1,3** and **4** and **3%** for **Ring2** to **minimize the orbit leakage** → H- beam correctly centred at H0 and H- with BSW OFF and ON
- **Vertical steering** only adjusted by **minimising the injection oscillations**, through orthogonal steering, with respect to the closed orbit established with all the bumps off
- **Residual orbit leakage in vertical plane in particular** for Ring 2 → compatible with **roll angle** of ~ 6 mrad (1-2mrad specified) → confirmed by Survey measurements → realigned at next winter stop → possible achieve expected $\leq \pm 2$ mm orbit closed orbit at injection

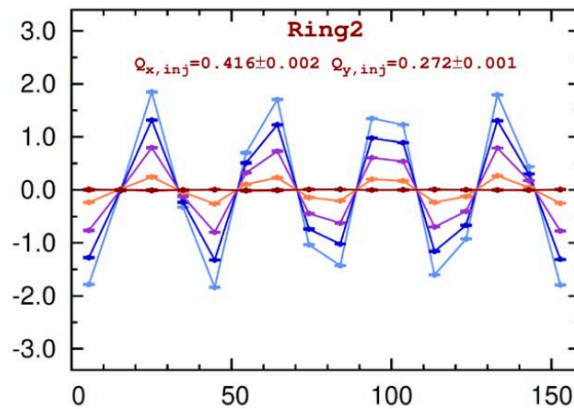
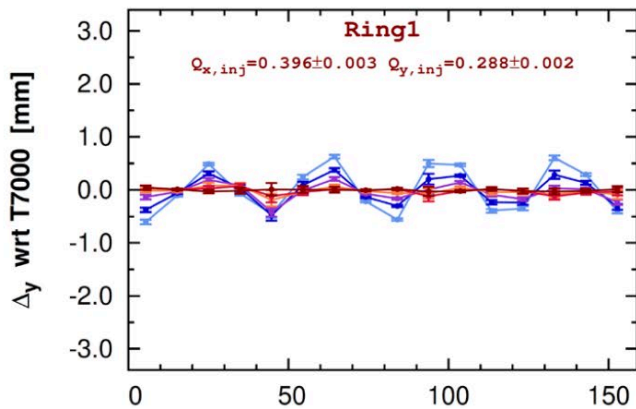

E. Maclean

Column				← BEAM direction	Beam level
1L1.4	1L1.3	1L1.2	1L1.1		
0.58	0.67	0.52	3.16	BSW4	
-1.20	1.82	1.70	3.36	BSW3	
-0.68	5.42	5.23	5.35	BSW2	
1.06	3.92	4.83	4.04	BSW1	

vertical orbit leakage now systematically used to check BSW alignment after interventions

Commissioning 2020/2021

- **Angular steering** centering beam at **H0 monitor** with **no foil** and **BSW OFF** → **Beam not centered** at **H-monitor** with **BSW ON** + **large horizontal orbit leakage** before BSW decay when injecting beam in the ring
- **Nominal current** of **BSW2,3** and **4** (3400 A) had to **be reduced by 3%** and **BSW1** current (6700 A) **increased by 2.5%** → H- beam correctly centred at H0 and H1
- **Vertical steering** of beam with respect to the closed orbit → orthogonal steering, with roll angle of ~ 6 mrad
- **Residual orbit leakage** (1-2mrad specified) after stop → possible to achieve expected ≤ 1mrad

Present operation:

- Tight time for the recommissioning after each winter stop
- Injection setup limited to:
 - TL steering to previously defined references
 - Preliminary centring of beam on the BTV
 - Minimisation of the injection oscillations and current at the H- monitor
- TL and orthogonal steering periodically performed to compensate for natural drifts, equalise emittances in four rings and rematch to requirements of different users.

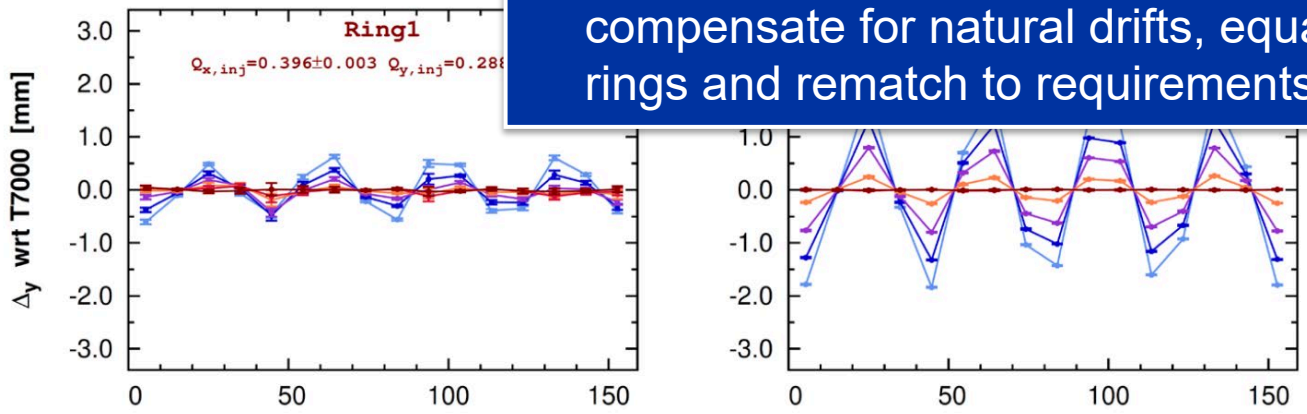

E. Maclean

				← BEAM direction	
				L1.1	
0.58	0.67	0.52	3.16	BSW4	Beam level
-1.20	1.82	1.70	3.36	BSW3	
-0.68	5.42	5.23	5.35	BSW2	
1.06	3.92	4.83	4.04	BSW1	

vertical orbit leakage now systematically used to check BSW alignment after interventions

Injection Painting Setup and Optimisation

- Initially **theoretical waveforms** as calculated with **tracking simulations** applied
- Fine tuning** performed to achieve **target emittance and minimize losses**
- Offsets in vertical plane applied in some cases to match conditions in vertical plane
- Applied painting and achievements:
 - LHC**: obtained brightness regularly **beyond specifications** (1.). Promising result in view of production of the HL-LHC beams (40% higher intensities in $<1.7 \mu\text{m}$), already successfully prepared in MDs
 - VDM** (low intensity and relatively large emittance): possibility of **decoupling number of injection turns (3)** and the **KSW flat-top duration (150)**. Particles are scattered by the interaction stripping foil \rightarrow emittance blow up (2.)
 - ISOLDE**: same stored intensity as before LS2 (losing 30-40% of the beam at injection) now systematically reached **keeping losses at 2.5%** over the full cycle (when optimised $<1\%$) up to the end of the acceleration process (3.). MDs performed to assess reachable intensity injecting over 148 turns with longitudinal painting and adapted KSW waveform \rightarrow **1.25×10^{13} ppr** (4.). Further optimization possible aiming for **ultimate intensity** reach of **1.6×10^{13} ppr**

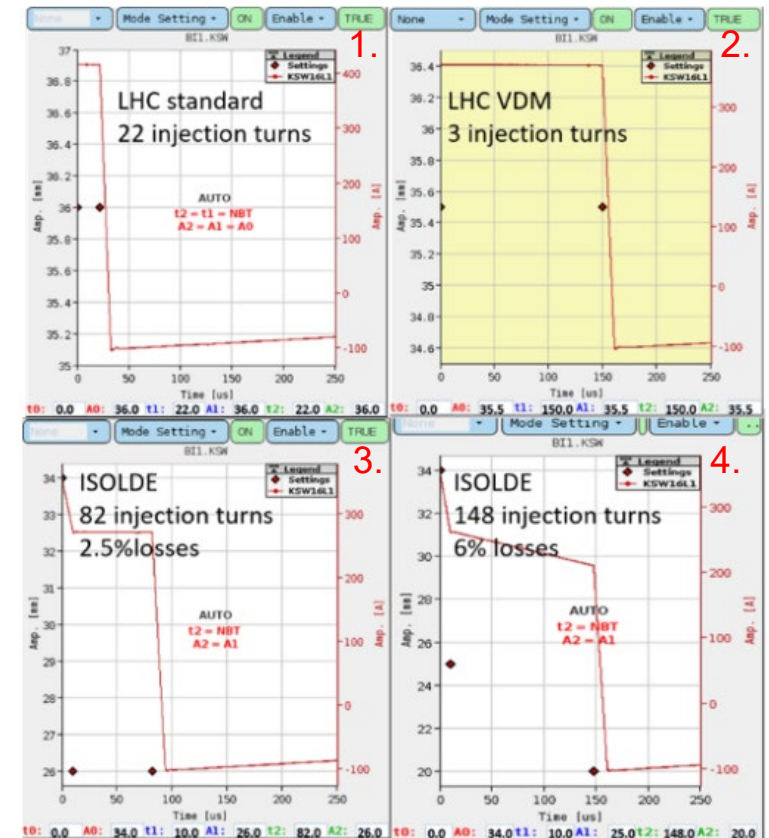

	Target		Achieved	
	Intensity 10^{10} ppr	$\epsilon_{x,y}$ μm	Intensity 10^{10} ppr	$\epsilon_{x,y}$ μm
LHC	250	$\leq 1.5-1.5$	250	$\leq 1.2-1.3$
VDM	1	2.5-2.5	1	2.3-2.6
ISOLDE	800	10-6	800	10.5-7.2

PSB Stripping Foil System Operational Experience

No foil broken due to beam impacts (only during vacuum pump down or for mechanical reasons)

Only small/large plastic deformation is visible

Still $\geq 98\%$ stripping efficiency \rightarrow keep using same foils (lifetime studies) but for Ring 2 (broken)

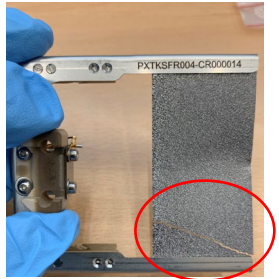

Before beam exposure

After beam exposure

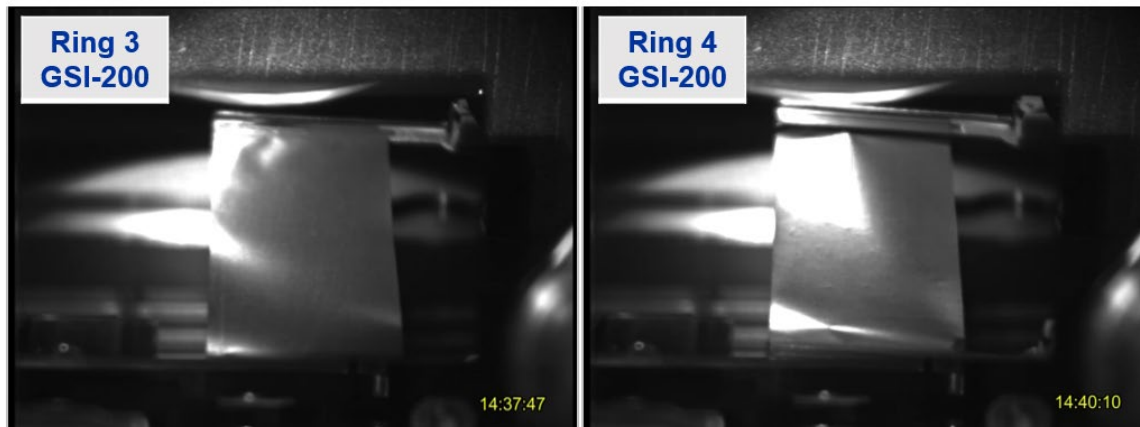
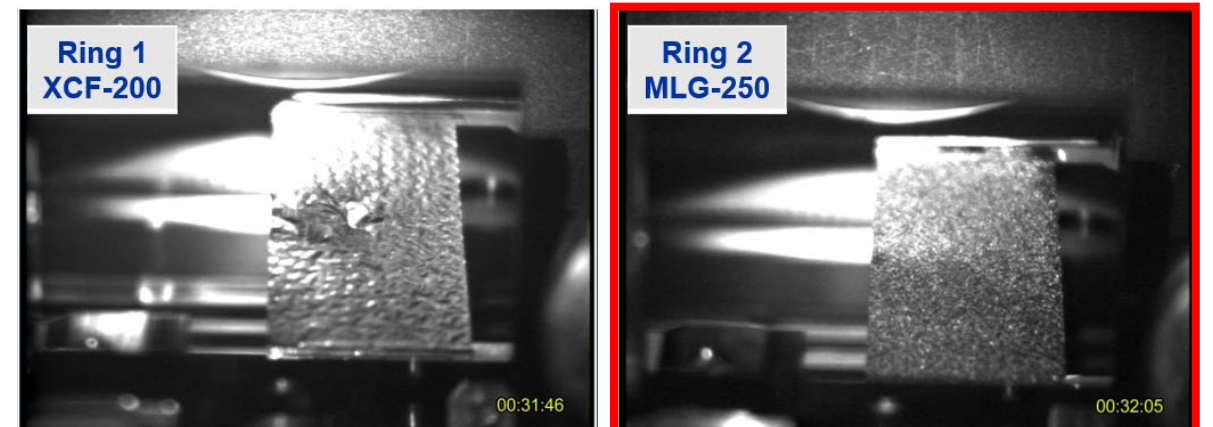
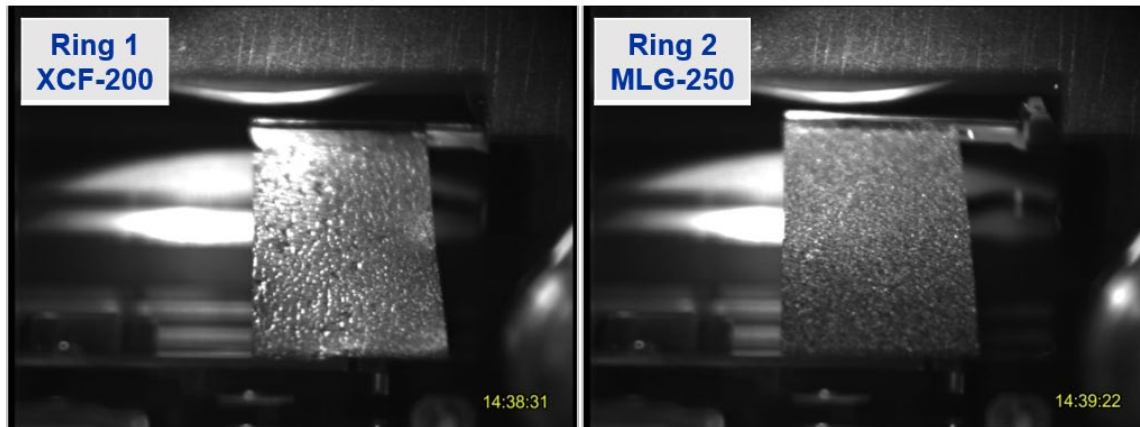

PSB Stripping Foil System Operational Experience

No foil broken due to beam impacts (only during vacuum pump down or for mechanical reasons)

Only small/large plastic deformation is visible

Still $\geq 98\%$ stripping efficiency \rightarrow keep using same foils (lifetime studies) but for Ring 2 (broken)

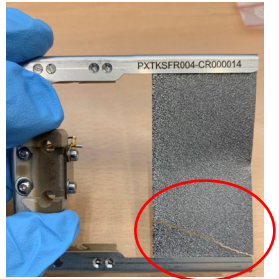

Before beam exposure

After beam exposure

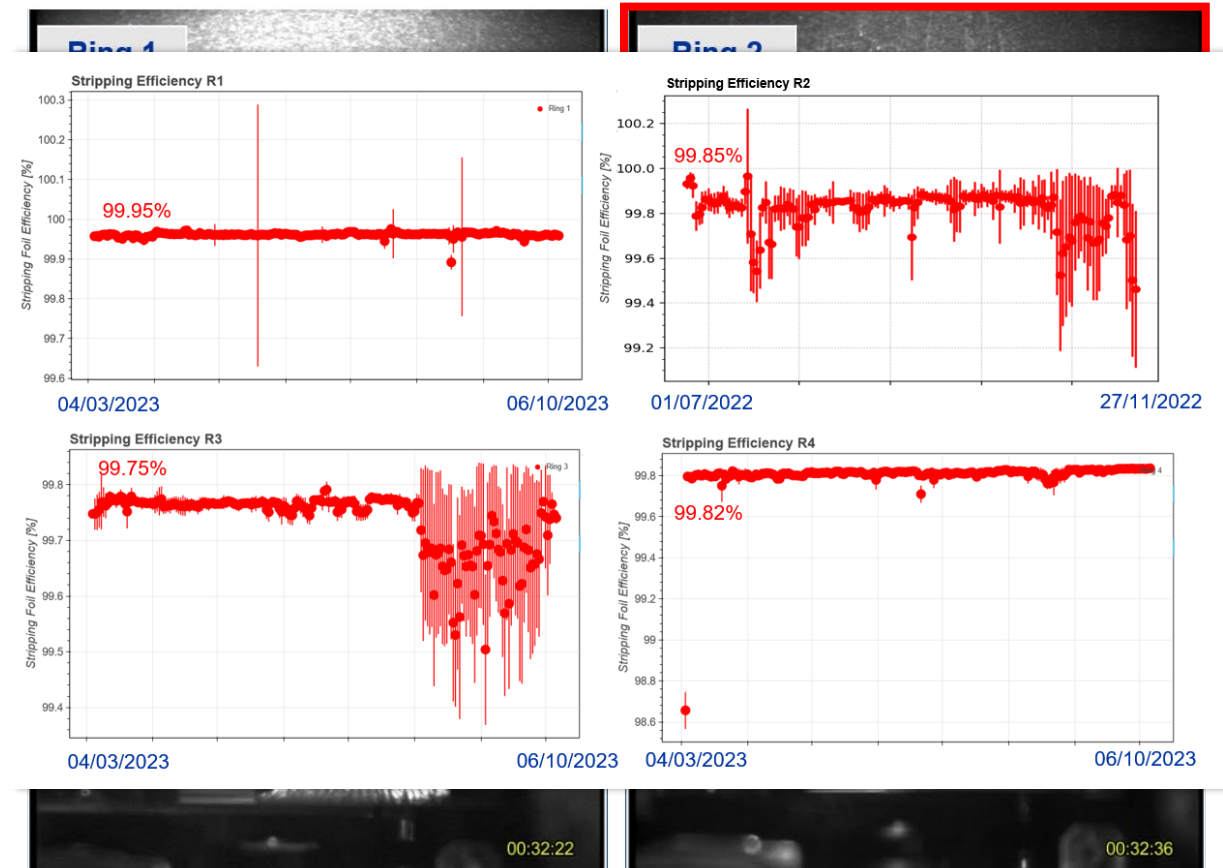
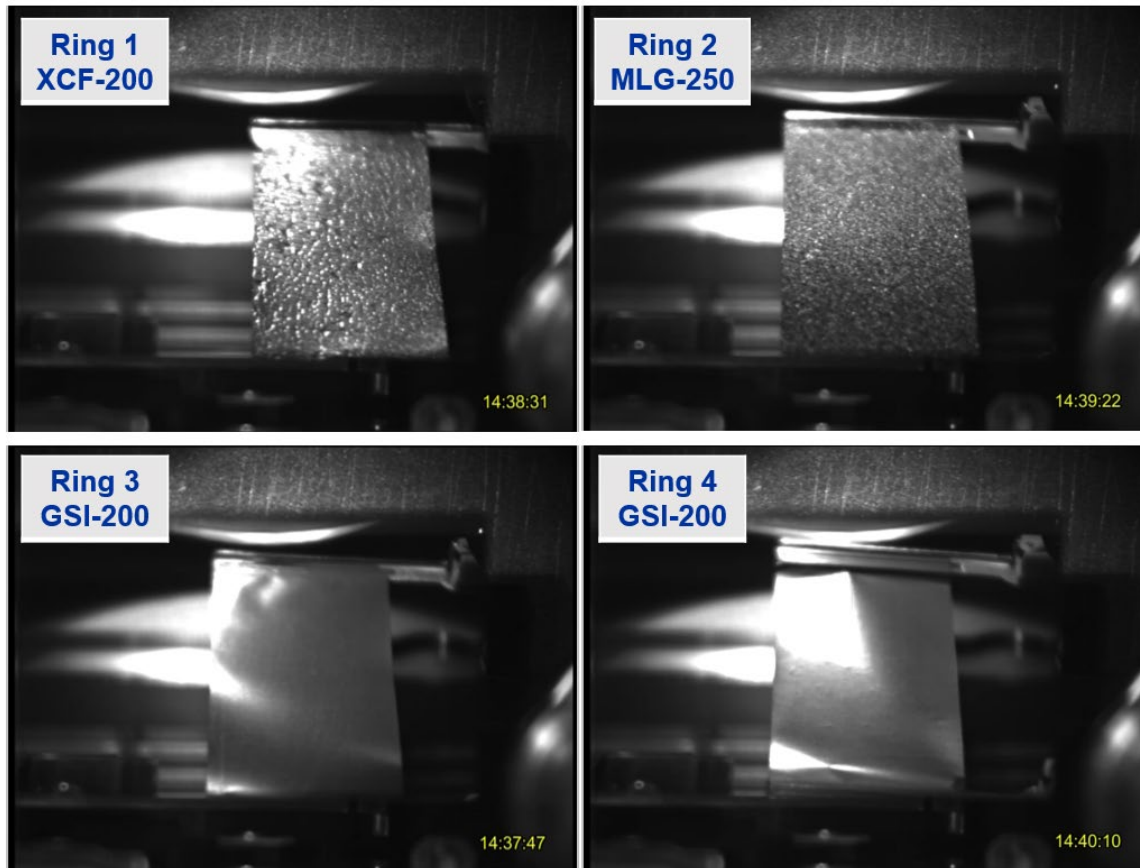

H⁰/H⁻ monitor of ring 3 – July 2022

- The stripping efficiency can be influenced by the steering of the beam at the foil (H⁻ ions not intercepting foil);
- The large standard deviation for Ring 3 data indicates that there is a steering problem for 1 or more users.
- When checking the different users, large signals were measured at H⁻ plates while H⁰ stayed constant;
- Also, when steering, only H⁻ signal was reduced and H⁰ remained unchanged;
- A clear correlation with the losses in the injection region (lower losses when steering the beam and reducing signal at H⁻ plate) is also observed;
- In general, from stripping we expect a higher signal in the H⁰ than the H⁻ plate, which is the case when the beam is properly steered.

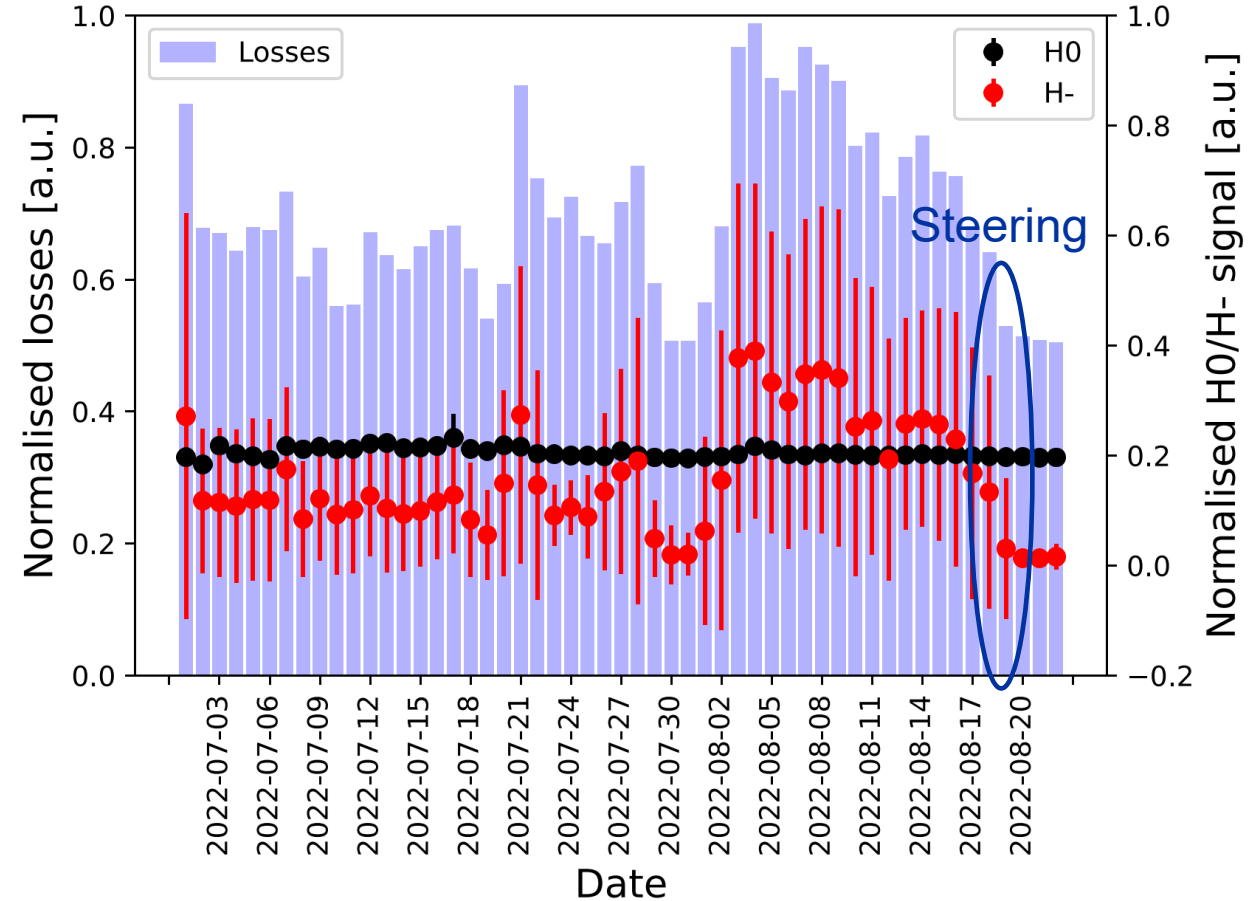

Foil Scattering Induced Emittance Increase [2]

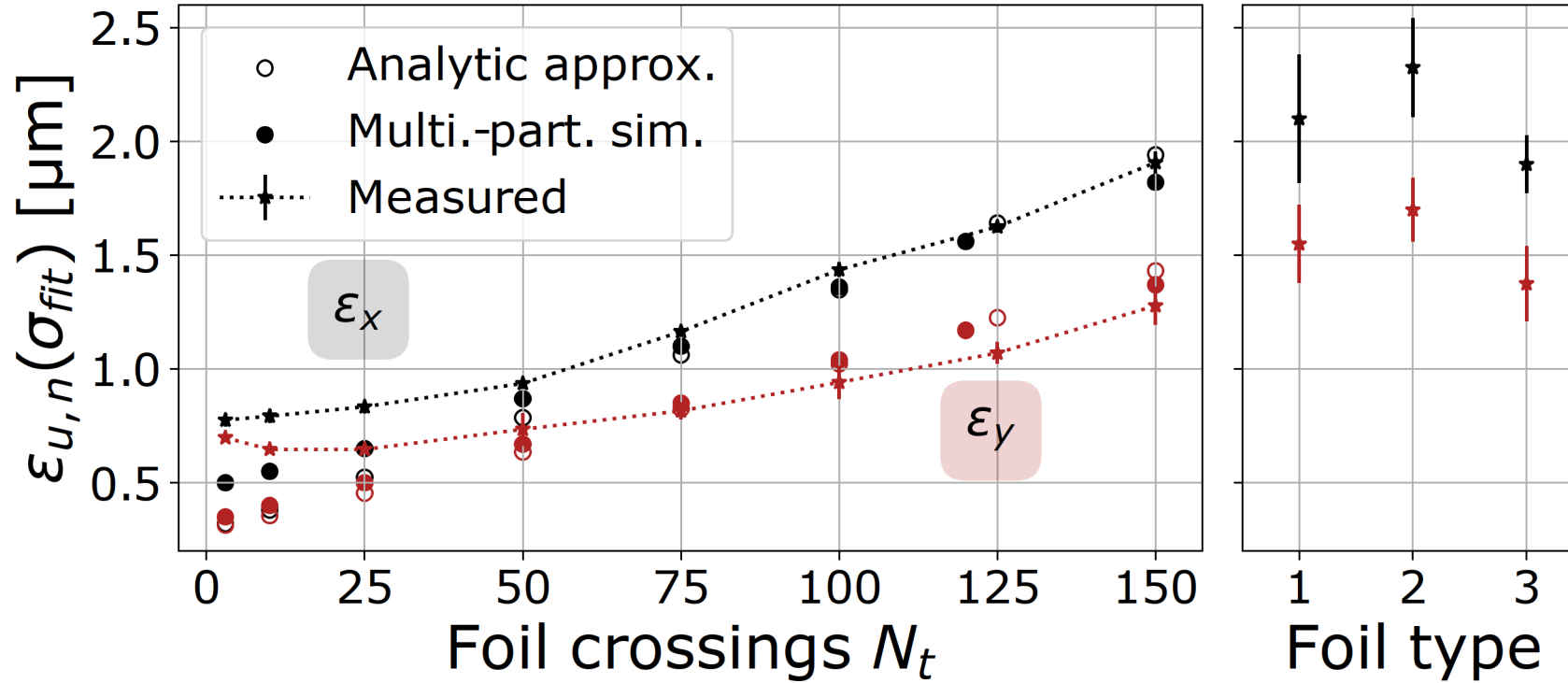

E. Renner

Type	Reference
1	XCF-200
2	MLG-250
3	GSI-200

Left: Transverse emittance measured for a varying foil crossings with GSI-200 foil.

Right: Transverse emittance measured with all foils for $N_t = 150$.

Measurements consistent with model and no significant foil induced beam degradation is expected for the production of high brightness beams (10 to 35 injected turns).

Future Development

- **Longer term (after LS3) goal:** fully exploit PSB potential in production of beams with **brightness and intensity even higher than specifications.**
- **Longitudinal painting and triple harmonic** → PSB RF bucket filling, reduce line density and thus the space charge related effects
- **Fine optimisation of the transverse painting, based on numerical optimisation algorithms**
- **Automatic tools** to constantly **survey** the **injection quality** (e.g. checking the losses, injection oscillations and TL steering) and **react** to compensate for drifts and operational changes → push the reliability and efficiency of the system.
- **Supervised machine learning algorithms** are considered as the most promising means to explore the universe of all possible additional improvements to apply to the injection system

S. Albright – THBP38

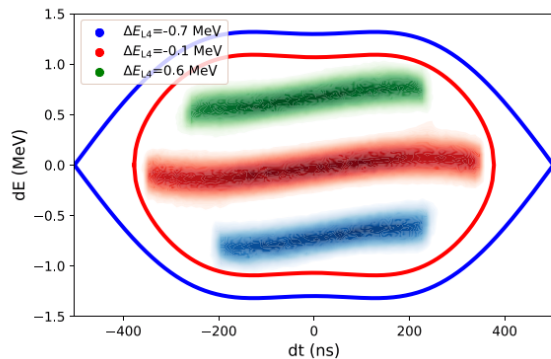

F. Asvesta – THBP09

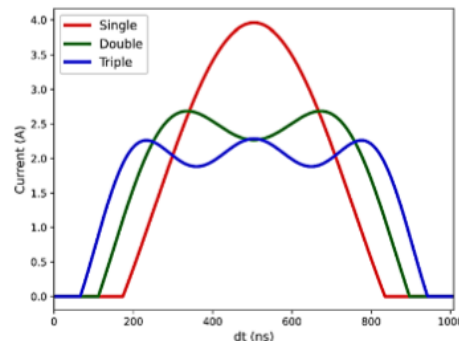

E. Renner – CERN-THESIS-2022-241

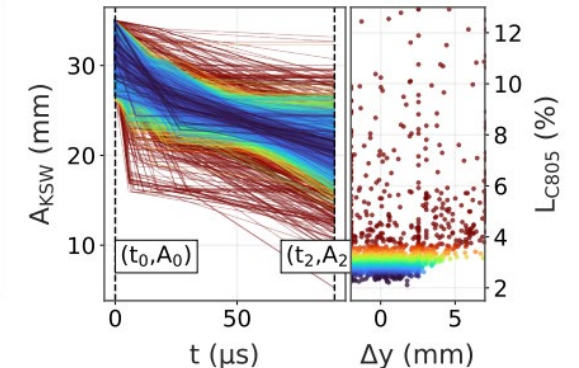
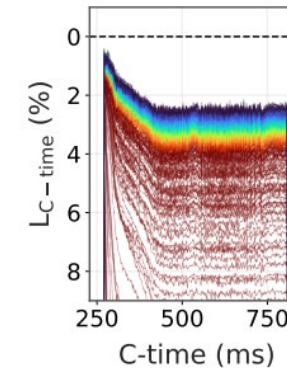
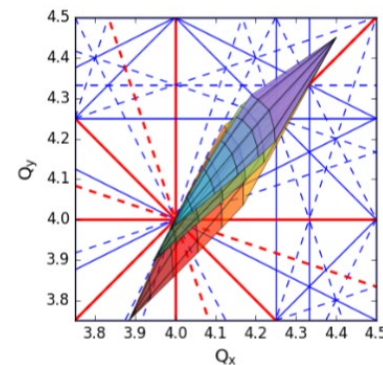

Conclusions

- **The new PSB H⁻ charge exchange system has been successfully in operation for the past three years**
- **The results achieved up to now in terms of beam quality meet the upgrade goals**
- **Studies to push the boundaries and assess the ultimate levels of the achievable intensity and brightness are continuously ongoing**

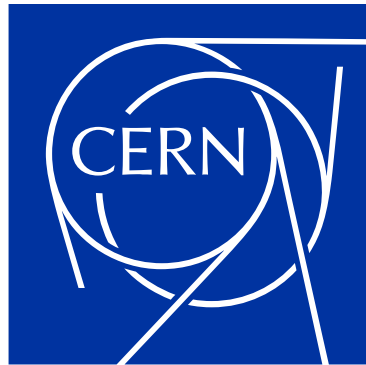

Thank you for your attention

home.cern