

STRIPLINE DESIGN OF A FAST FARADAY CUP FOR THE BUNCH LENGTH MEASUREMENT AT ISOLDE-ISRS

S. Varnasseri, I. Bustinduy, J.L. Muñoz, P. González, R. Miracoli



MINISTERIO
DE CIENCIA
E INNOVACIÓN



Plan de
Recuperación,
Transformación
y Resiliencia



Financiado por
la Unión Europea
NextGenerationEU



Objective

PROJECT OBJECTIVE

The objective is to reduce by a factor 10 the current frequency of the HIE-ISOLDE LINAC **101.28 MHz** for the optimum performance of the future ISRS spectrometer.

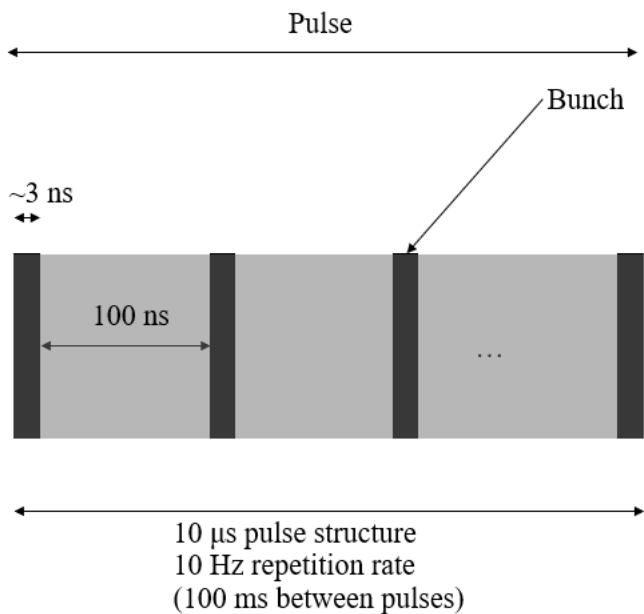

After MHB and RFQ

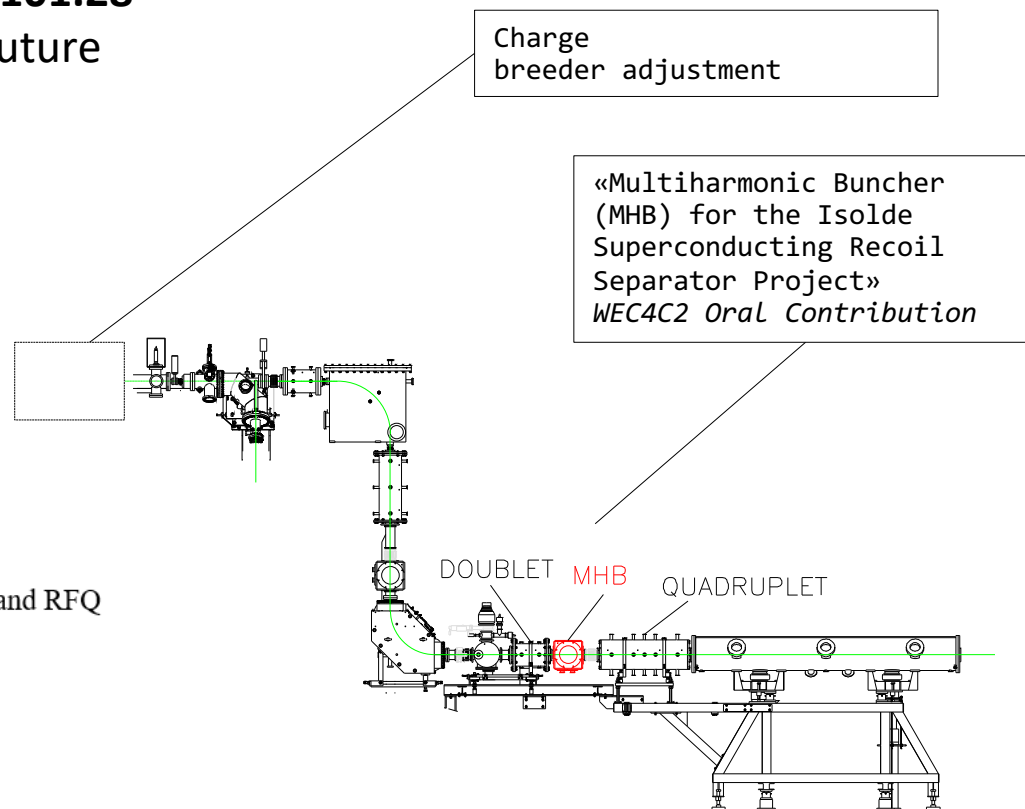

HIE-ISOLDE-PROJECT-Note-0035

Objective



PROJECT OBJECTIVE

The objective is to reduce by a factor 10 the current frequency of the HIE-ISOLDE LINAC **101.28 MHz** for the optimum performance of the future ISRS spectrometer.

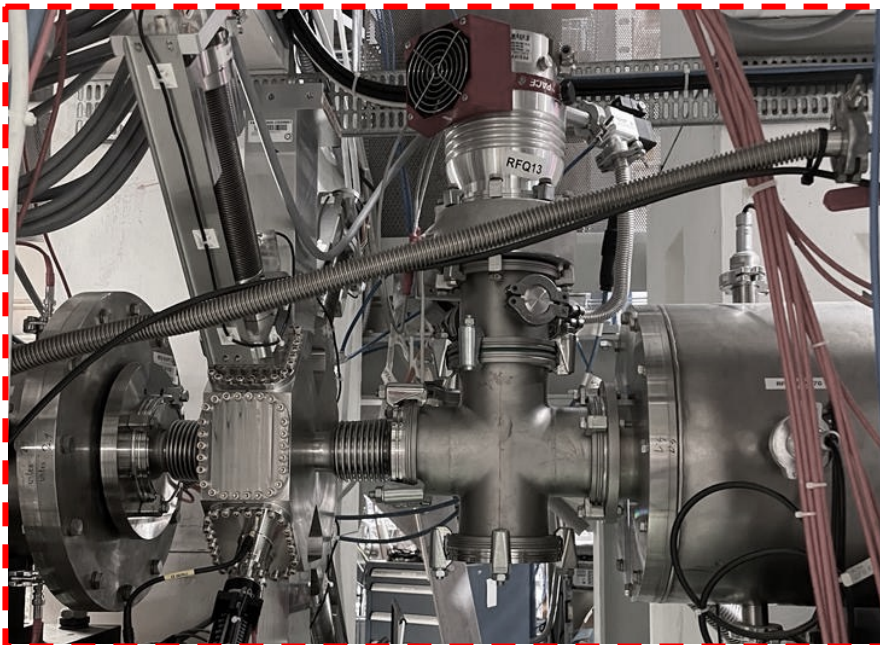

Charge breeder adjustment

«Multiharmonic Buncher (MHB) for the Isolde Superconducting Recoil Separator Project»
WEC4C2 Oral Contribution

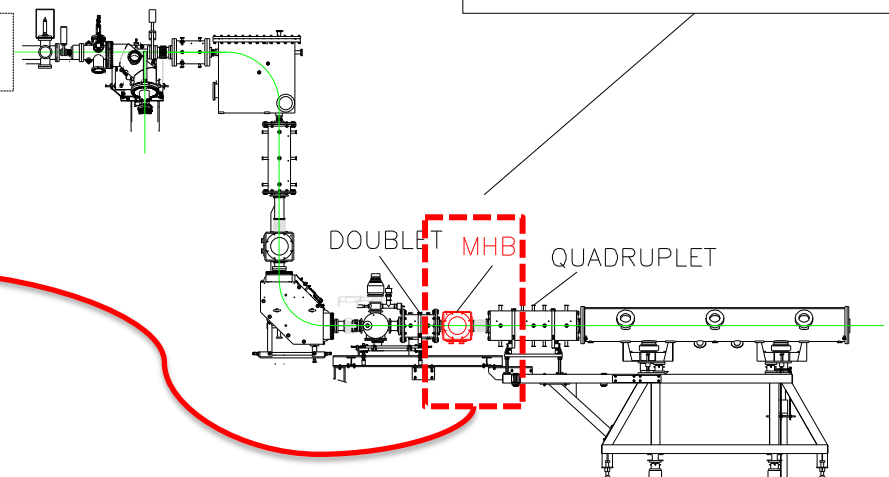

HIE-ISOLDE-PROJECT-Note-0035

Test bench for MHB

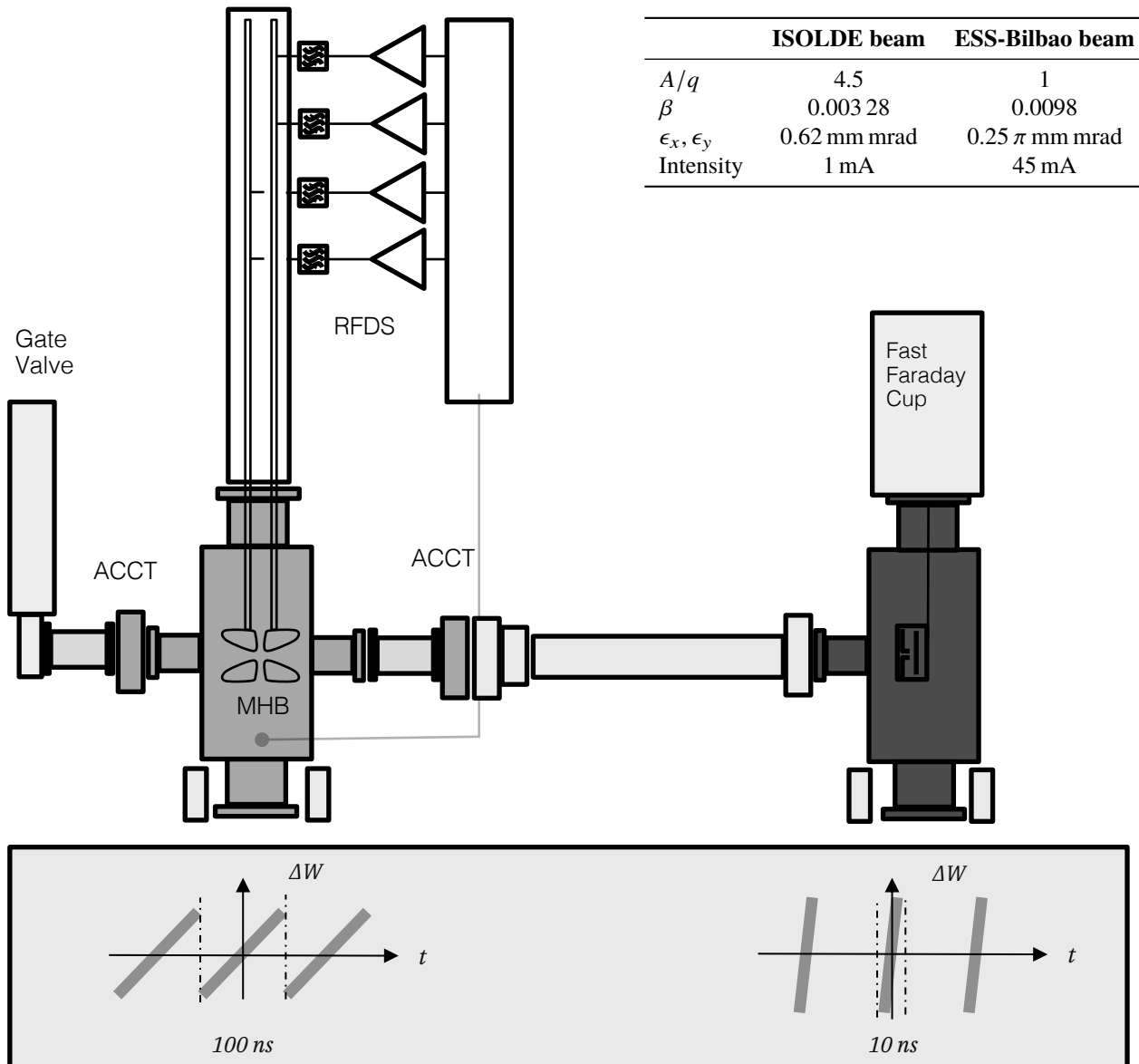

In order to validate the MHB, ESS-BILBAO ions source will be used to test and fine tune the MHB parameters.

This versatile Ion source provides H⁺, H₂⁺, H₃⁺, He⁺, N⁺. We can produced and measure from 50ns upto 3ms pulsed beams. Repetition rate (1-50Hz) can be adjusted. Extraction Energy is 45 keV/q, but we could go up to 75 keV/q with a new power supply, and adjusting the extraction system.

In order to confirm the transmission two beam current transformers (ACCT) are proposed before and after the MHB. After the bunching of the incoming beam, a (fast) faraday cup might be used to measure longitudinal bunch length for very low current beam. In case a focusing system is added.

Test bench for MHB

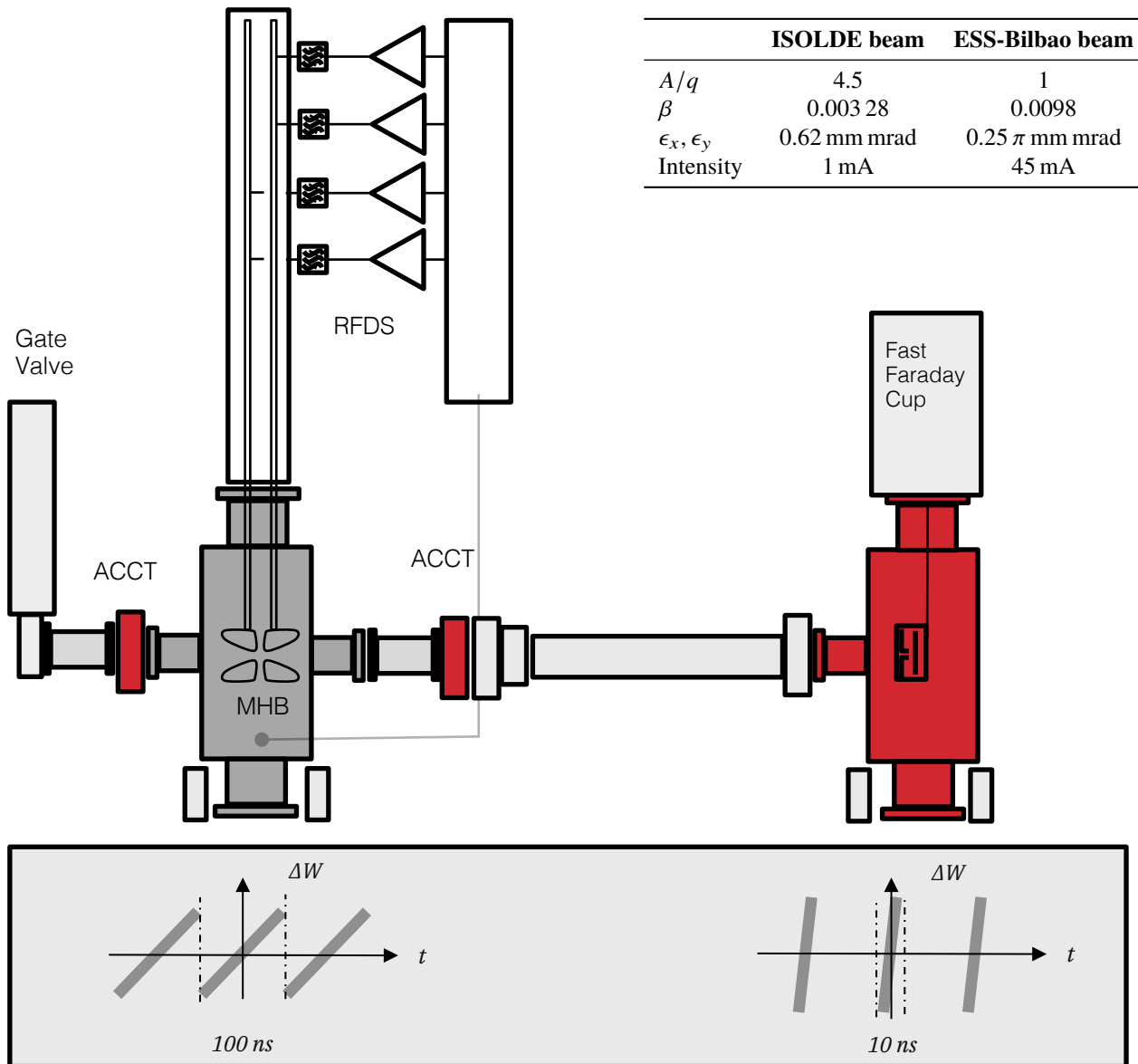

In order to validate the MHB, ESS-BILBAO ions source will be used to test and fine tune the MHB parameters.

This versatile Ion source provides H⁺, H₂⁺, H₃⁺, He⁺, N⁺. We can produced and measure from 50ns upto 3ms pulsed beams. Repetition rate (1-50Hz) can be adjusted. Extraction Energy is 45 keV/q, but we could go up to 75 keV/q with a new power supply, and adjusting the extraction system.

In order to confirm the transmission two beam current transformers (ACCT) are proposed before and after the MHB. After the bunching of the incoming beam, a (fast) faraday cup might be used to measure longitudinal bunch length for very low current beam. In case a focusing system is added.

FFC design inputs

The bunching develops just after the MHB and progressing its length variation.

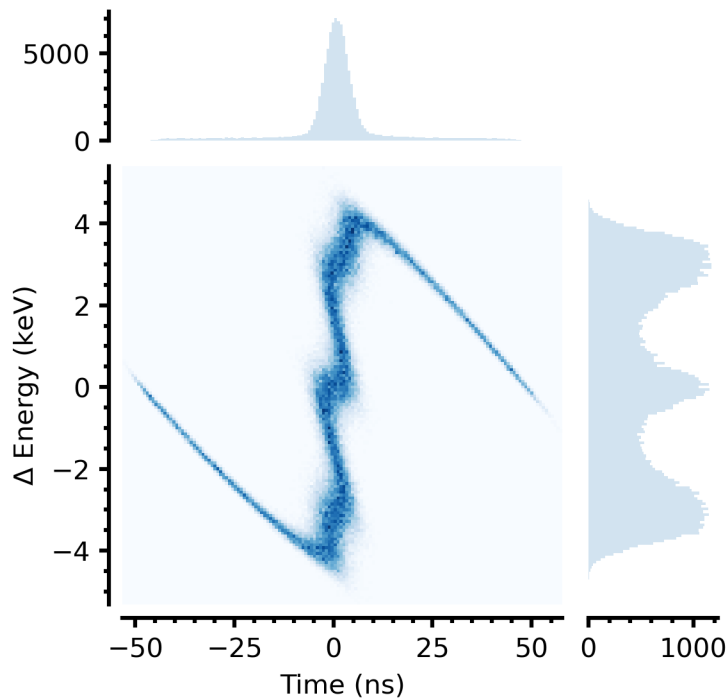

Bunch formation development at a distance of 1m from MHB. Horizontal axis corresponds to time (ns) and vertical axis to energy (keV). 8-12ns width

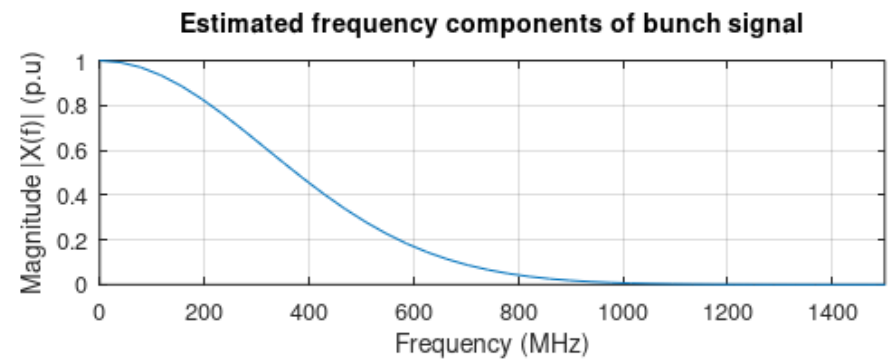
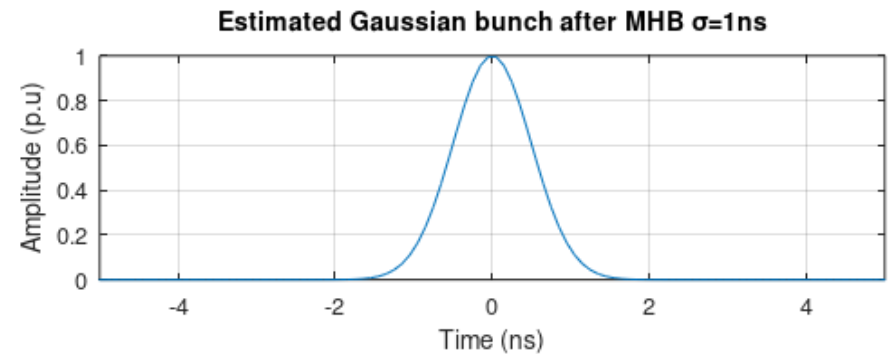

Expected shortest bunch temporal distribution and frequency spectrum after MHB in the FFC location. The frequency components goes up to 1 GHz.

FFC frequency and time

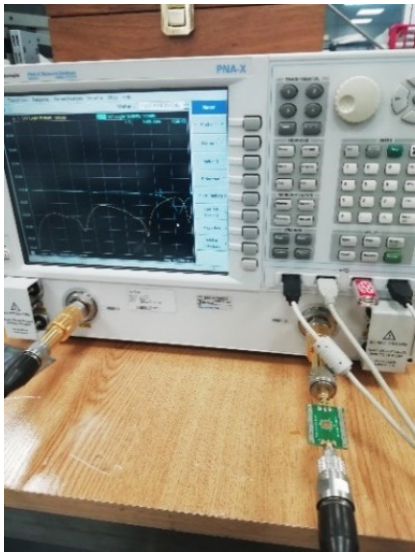

Frequency domain Measurements

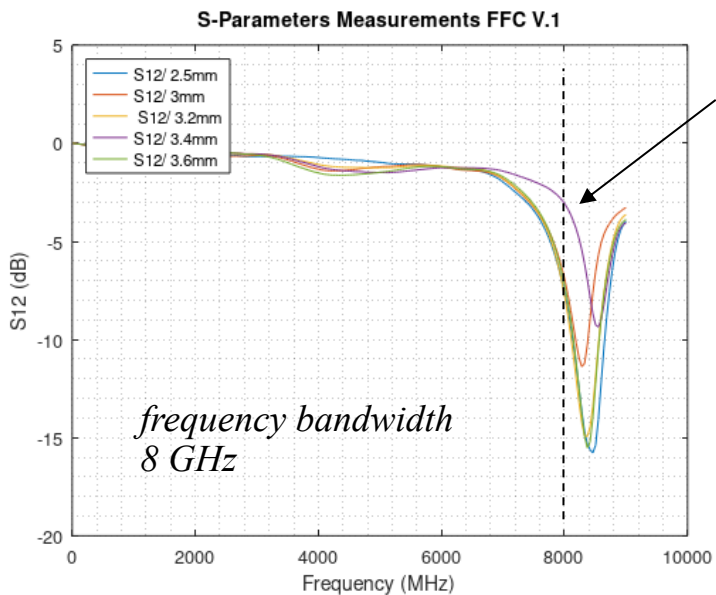
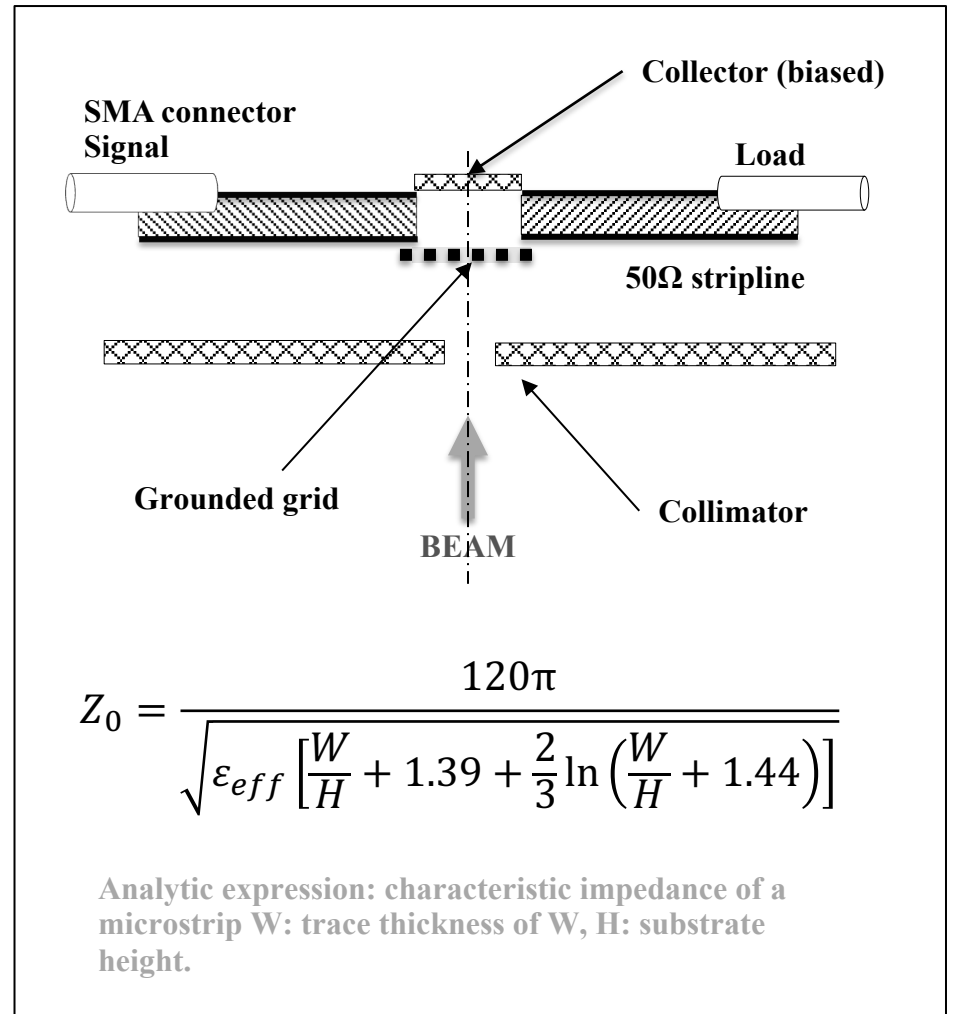

Selected design
 $W = 3.4 \text{ mm}$

Measured S12 parameters of various prototypes. Standard FR-4 substrate thickness of 1.5 mm

FFC frequency and **time**

Check the possible deformation of the temporal distribution of the bunch signal.

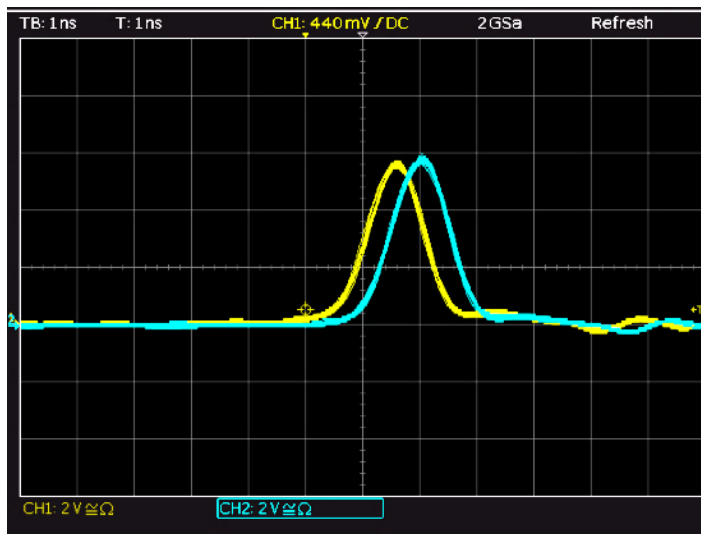

Temporal measurements with 1ns pulser.

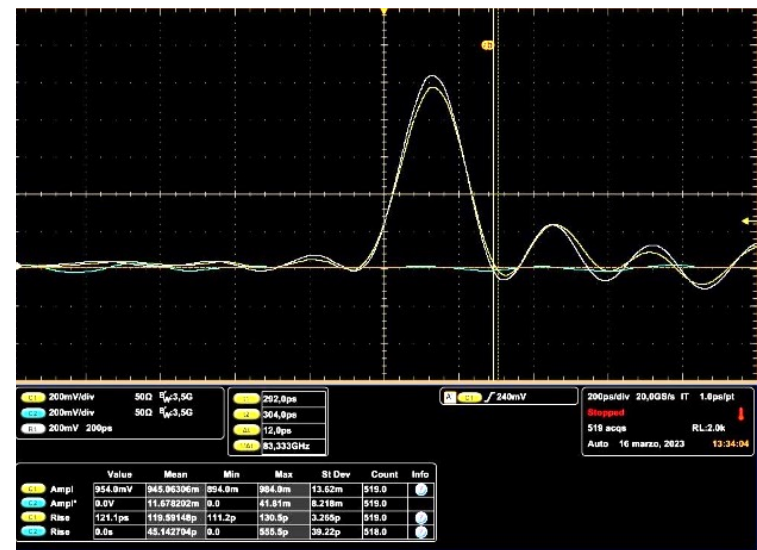

Temporal measurements with 115ps pulser.

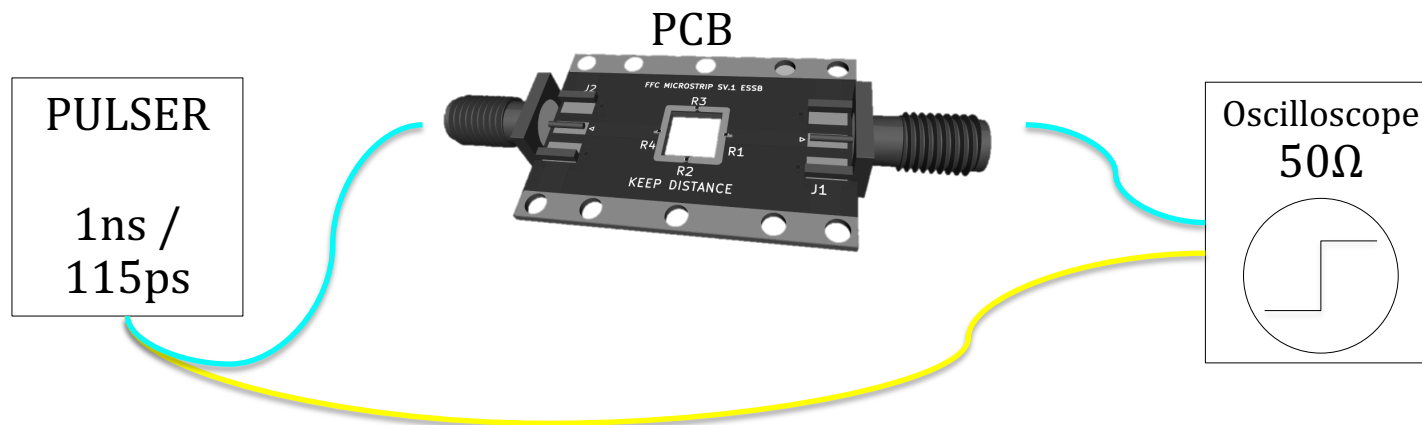

FFC close out

Summary:

- Stripline type FFC
- Ready for even shorter bunch lengths.

Future steps:

- Fine adjust some details on the PCB.
- Manufacture the rest of the FFC head components..

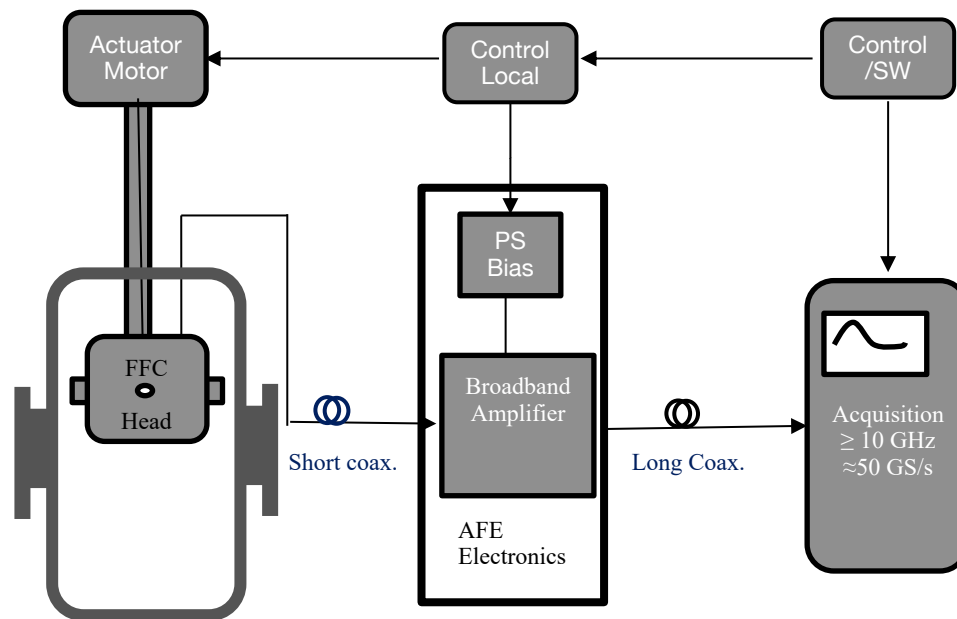

General Scheme of the Fast Faraday Cup interconnections

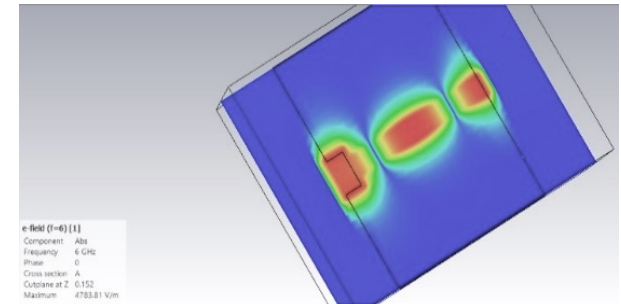

Mid-plane signal propagation in the FFC PCB

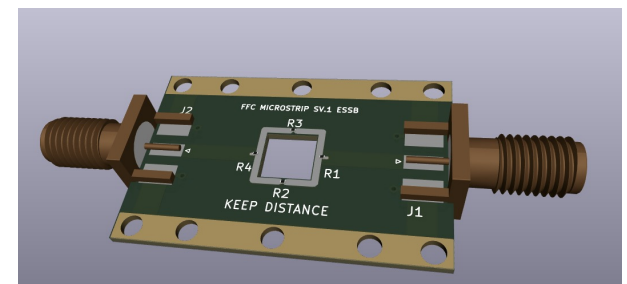

3D image of the FFC head without collimator